

ALLEN&HEATH

Parts identification sheet

XONE2:464

Version 2 identified by 2 in serial number

How to order parts

Parts must be ordered from our distributor in your territory. A list of international distributors can be viewed at <http://www.allen-heath.com/UK/distributors.asp>

UK parts must be ordered through an appointed A&H dealer or service centre. A list of UK service centres can be viewed at http://www.allen-heath.com/UK/service_centres.asp

POTS FADERS & KNOBS:

Pot nut
AB8172 

AJ3673 

5.5mm
AJ2864 

Lt blue
AJ3675 

Blue
AJ3674 

AJ3740 

AJ4251 

AJ4310 





Gain
AI8111 

EQ
Freq Hz
AI8005 

EQ HI, LO,
+/-
AI8004 

Aux
AI8003 

Pan
AI8008 

Fader
AI8117 

Aux
AI8003 

Gain
AI8006 

EQ
HI, MID1,
MID2, LO
AI8006 

Fader
002-684 



AJ2961 

Aj4245 

AJ8107 

AJ2960 

EXT IN
AI8007

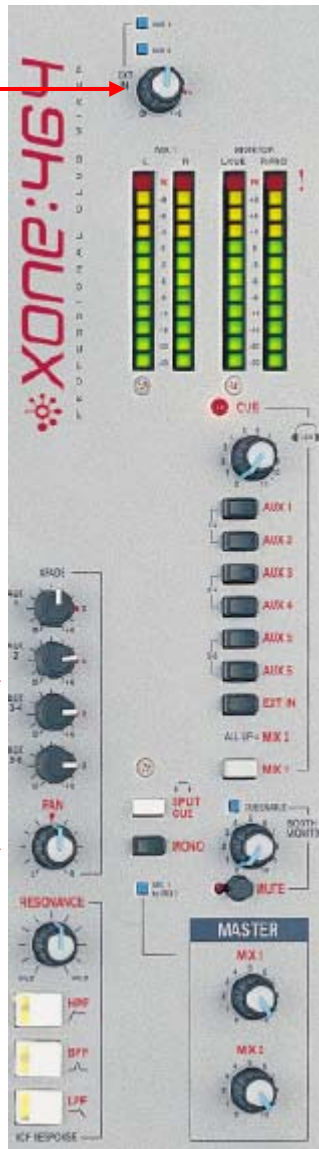

Aux mix
AI8003

Pan
AI8008

Resonance
AI8003

H/phones
AI8007

AJ7182

AJ7179

AJ7180

Booth
AI8007

MIX1/2
AI8007

The VERSION 2 model uses the Penny & Giles crossfader assembly :

XONE:464 Crossfader Assembly Part number 002-719

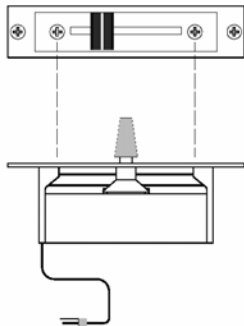

5mm
AJ2052

AJ5320

VCF
AI8003

AJ4246



AI0328

Fader plate
AA4231

RCA phono
AL3753

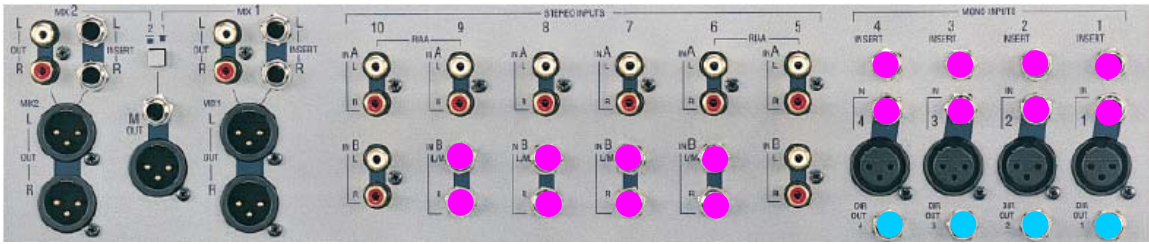

o/p XLR
AL2411



i/p XLR
AL2410



AL8106



AJ8071



Phones
AL8114



Blank plate
AA2407

Fuse holder
AL3178

AC inlet
AL3458

AJ2887



AJ2887



Switched jacks.
AL3410

Line In
Insert
Left/Mono IN
Right IN
Ext IN

Un-switched jacks.
AL3407

Direct Out
Aux
Local Monitor L/R

INTERIOR PARTS:

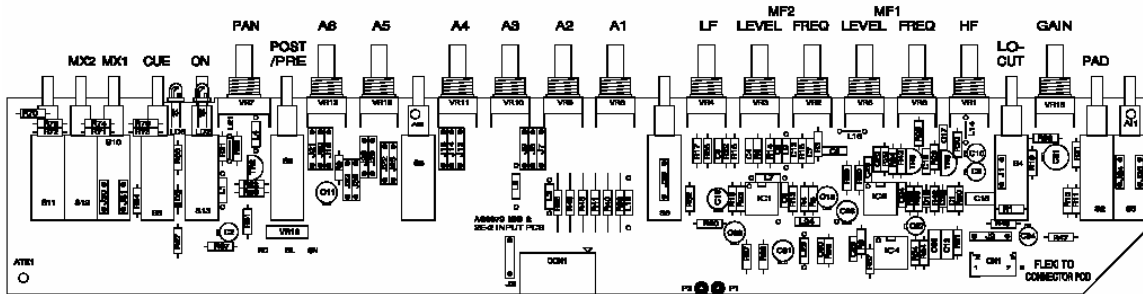

Mic/line input 002-517

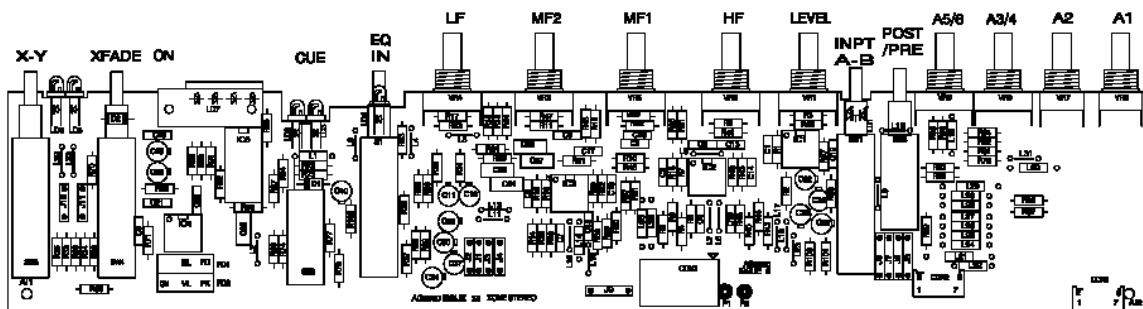

Stereo input 002-687

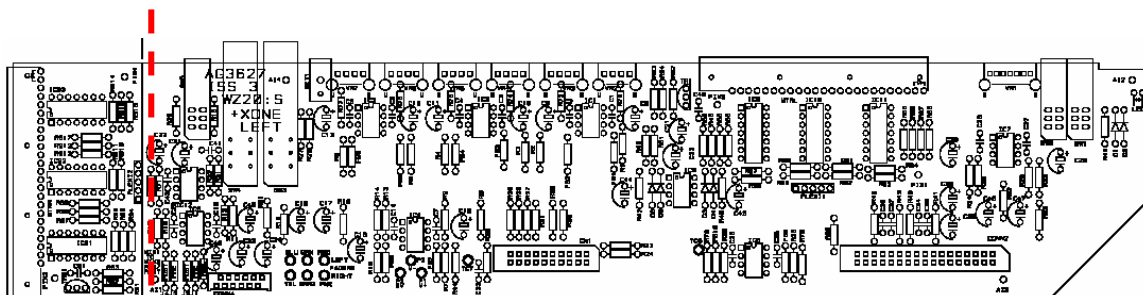

Break-off Meters

Left PCB 002-691

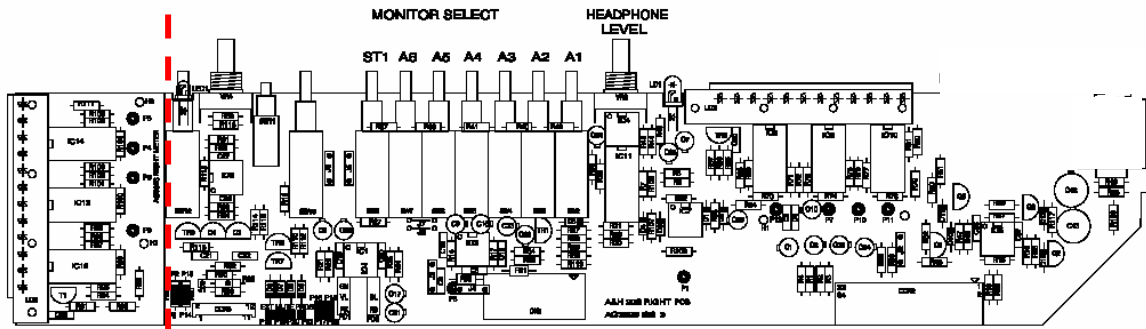

Break-off
Meters

Right PCB 002-622

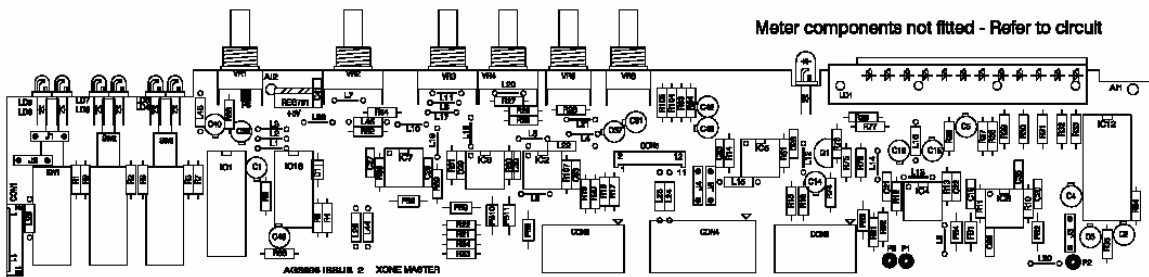

Master PCB 002-510

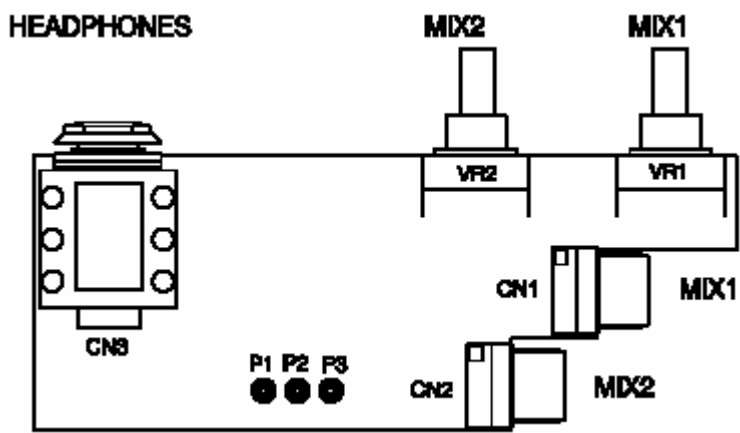

Rotary / Headphones 002-650

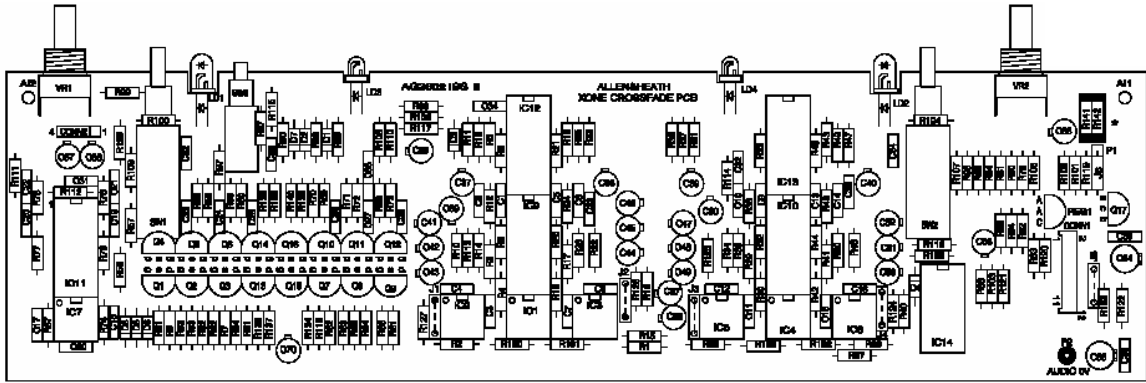

X fade 002-627

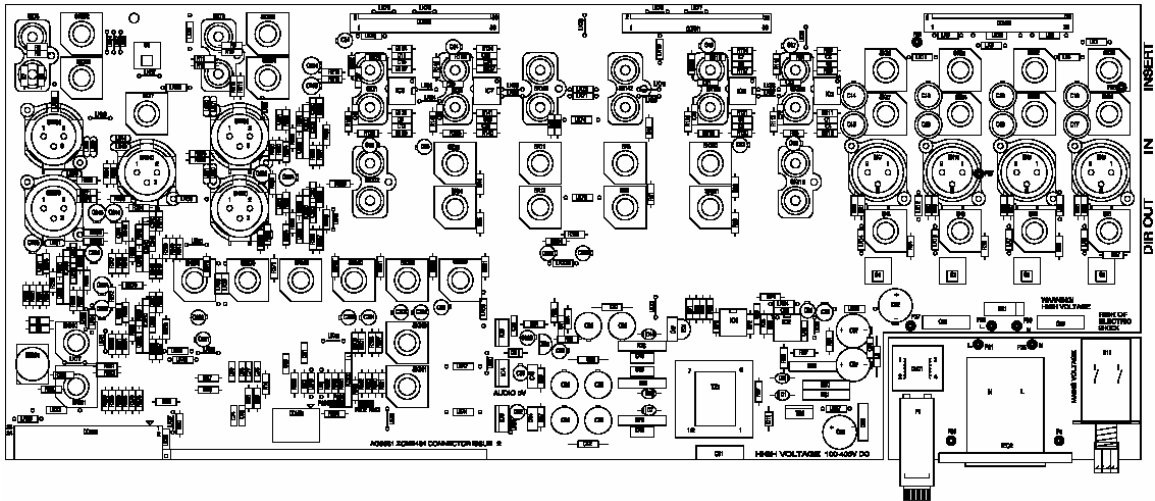

Connector
AC inlet
PSU

002-504