

ALLEN&HEATH

Parts identification sheet

Xone:92

How to order parts

Parts must be ordered from our distributor in your territory. A list of international distributors can be viewed at <http://www.allen-heath.com/UK/distributors.asp>

UK parts must be ordered through an appointed A&H dealer or service centre. A list of UK service centres can be viewed at http://www.allen-heath.com/UK/service_centres.asp

Screw AB3818 top panel to chassis SILVER.
 Screw AB3329 top panel to chassis STORM GREY.
 Screw AB3819 fader & x-fader SILVER.
 Screw AB0070 fader & x-fader STORM GREY.



MIC/RTN channel

POTS FADERS & KNOBS:

Knob small black
AJ5386



Small switch cap
AJ5388



Large switch cap
AJ4251

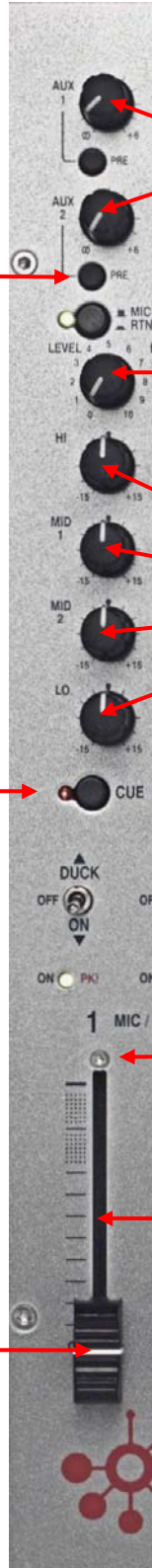

MIC/RTN fader
knob
AJ4310

Aux pot
AI8007



Level pot
AI8007



EQ
HI, MID1, MID2, LO
AI8006



Fader screw
AB3329



MIC/RTN fader
002-684



Front panel
Silver AA5319
Storm grey
AA7581



X-fader & filters

Black knob small
AI5386

Black button
AI5325

Black knob large
AI5387

Large switch cap
AJ4251

Xfade curve
very small
black knob
AJ5558

X-fader
002-719

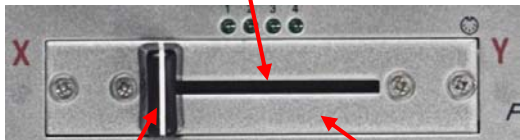
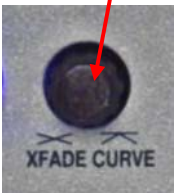

Xone x-fader
knob
AJ4251

Fader plate
storm grey
AA7492



DATA, MIDI
pot
AI8004

LFO DEPTH
pot
AI8003

RESONANCE
pot
AI8007

FREQ pot
AI8003

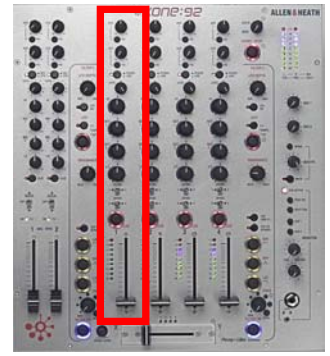

Stereo channel

Black knob small
AI5386



Small switch cap
AJ5388



Large switch cap
AJ4251



Black knob large
AI5387





Aux pot
AI8007



Level pot
AI8006



EQ
HI, MID1, MID2, LO
AI5317



1-2 X-Y
Toggle switch
AI5328



Line fader
003-144



Xone fader knob
AJ5320





Monitor section



Black knob small
AI5386



MIX 1-2
AI8007



Large switch cap
AJ4251



Booth pot
AI8007



Small switch cap
AJ5388



CUE ADD MIX
AI8003



Large headphone socket
AL0328



Headphone level
AI8007



Small headphone socket
AL5323



Phono shorting plug
AL4396

AC inlet
AL3458

MIDI
AL3962

RCA Phono
AL4977

Ground post
AL8106

XLR female
AL2410

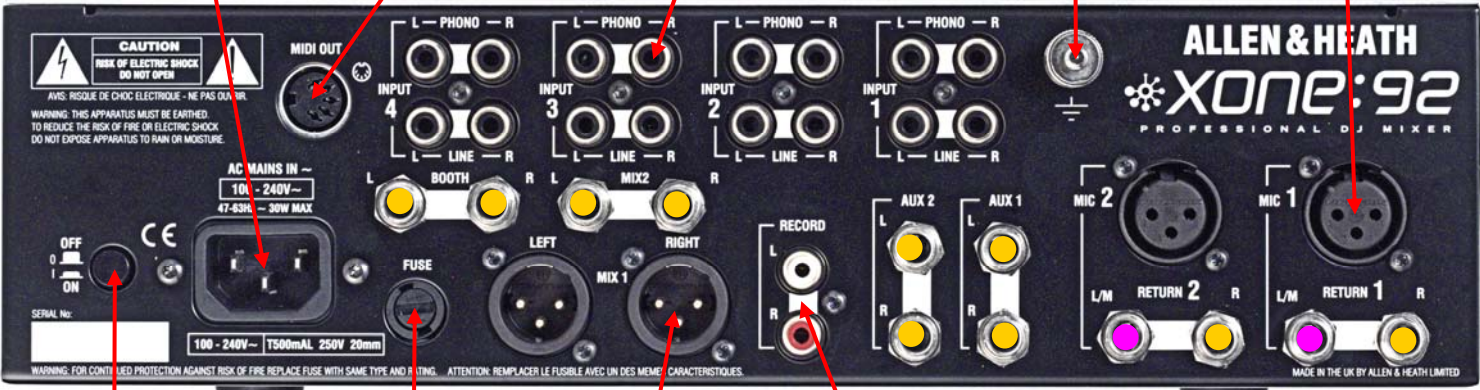

Switch
AL3338

Fuse holder
AL3178

XLR male
AL2411

RCA phono
AL3753

Jack
AL3410

Button
AJ2887

Fuse
AL3534

Jack
AL3407

INTERIOR PARTS:

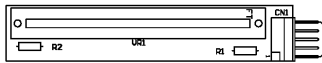

Stereo fader 002-684



Linear fader 003-144



Rotary fader 003-145 (92R)

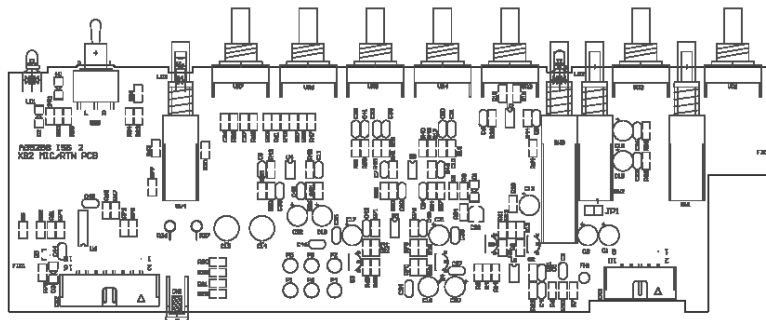

Mic/Stereo Return 003-136

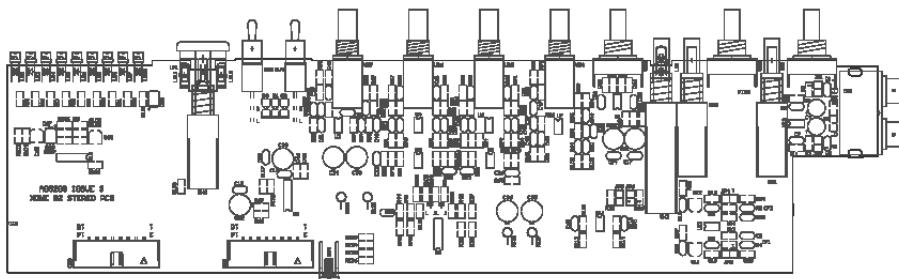

Stereo 003-137

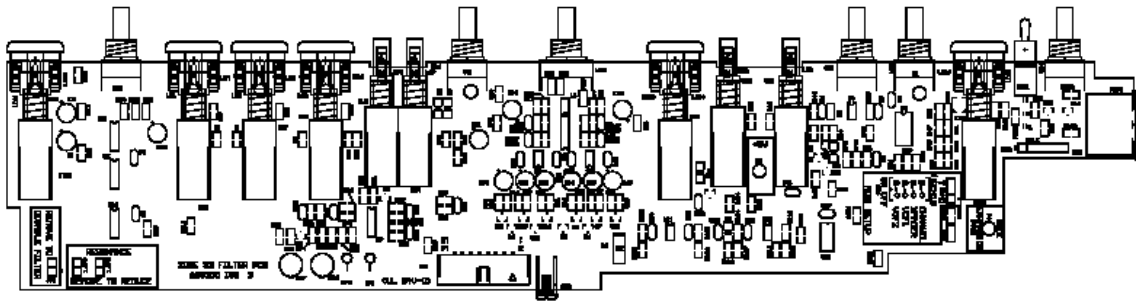

Filter 003-138

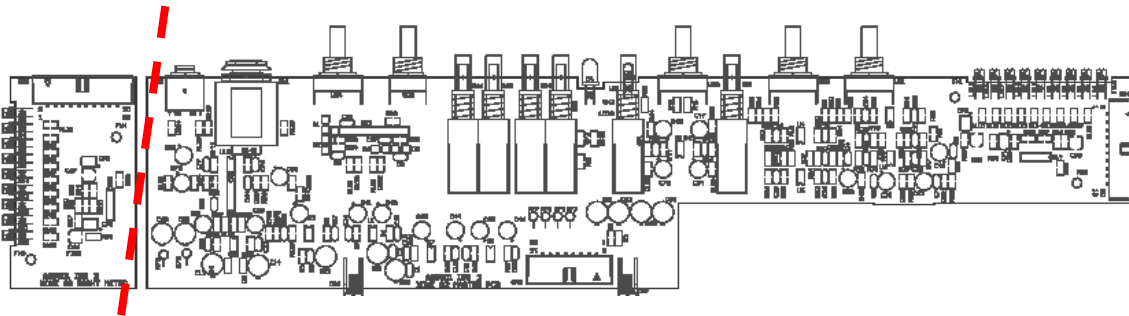

Meter snap-off

Master 003-139

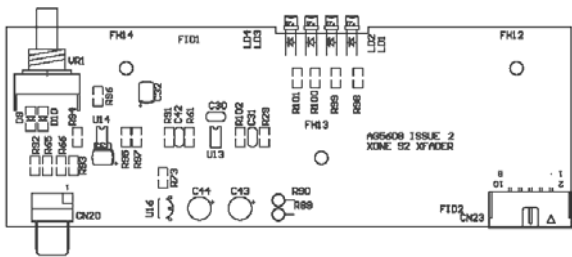

Xfade 003-140

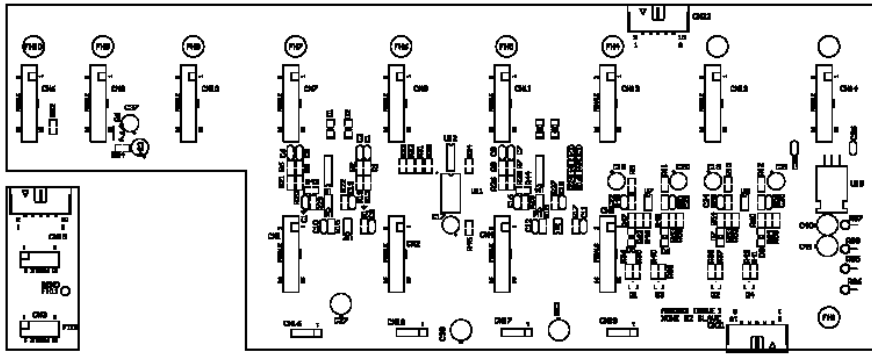

Slave 003-141

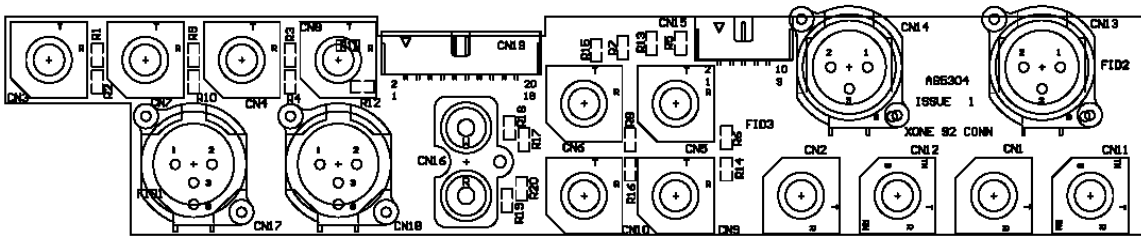

Connector 003-142