

# ALLEN & HEATH



# **XONE:20**

## USER GUIDE

Publication AP6908

## **Limited One Year Warranty**

This product is warranted to be free from defects in materials or workmanship for period of one year from the date of purchase by the original owner.

To ensure a high level of performance and reliability for which this equipment has been designed and manufactured, read this User Guide before operating. In the event of a failure, notify and return the defective unit to ALLEN & HEATH Limited or its authorised agent as soon as possible for repair under warranty subject to the following conditions

### **Conditions Of Warranty**

The equipment has been installed and operated in accordance with the instructions in this User Guide.

The equipment has not been subject to misuse either intended or accidental, neglect, or alteration other than as described in the User Guide or Service Manual, or approved by ALLEN & HEATH.

Any necessary adjustment, alteration or repair has been carried out by ALLEN & HEATH or its authorised agent.

This warranty does not cover fader wear and tear.

The defective unit is to be returned carriage prepaid to ALLEN & HEATH or its authorised agent with proof of purchase.

Units returned should be packed to avoid transit damage.

In certain territories the terms may vary. Check with your ALLEN & HEATH agent for any additional warranty which may apply.

 This product complies with the European Electro magnetic Compatibility directives 89/336/EEC & 92/31/EEC and the European Low Voltage Directives 73/23/EEC & 93/68/EEC.

This product has been tested to EN55103 Parts 1 & 2 1996 for use in Environments E1, E2, E3, and E4 to demonstrate compliance with the protection requirements in the European EMC directive 89/336/EEC. During some tests the specified performance figures of the product were affected. This is considered permissible and the product has been passed as acceptable for its intended use. Allen & Heath has a strict policy of ensuring all products are tested to the latest safety and EMC standards. Customers requiring more information about EMC and safety issues can contact Allen & Heath.

XONE:2D User Guide AP6908 Issue 2

Copyright © 2008 Allen & Heath Limited. All rights reserved

Allen & Heath Limited

Kernick Industrial Estate, Penryn, Cornwall, TR10 9LU, UK

<http://www.allen-heath.com> <http://www.xone.co.uk>

# CONTENTS

Congratulations on purchasing the Allen & Heath Xone:2D Professional Digital Music Interface. To ensure that you get the maximum benefit from the unit please spare a few minutes familiarising yourself with the controls and setup procedures outlined in this user guide. For further information please refer to the additional information available on our web site, or contact our technical support team.

<http://www.xone.co.uk>

<http://www.allen-heath.com>

Warranty .....	2
Software Installation PC.....	3
Packed Items .....	4
Power Supply .....	5
Software Installation PC.....	6
Checking the Windows Driver Installation .....	8
Software Installation Apple Mac .....	9
Checking the Mac Driver Installation .....	11
MIDI Channel Setup.....	12
MIDI Map and Light Pipe Setup .....	13
Using the Digital I/O .....	14
Soundcard Routing .....	15
Ableton Setup.....	16
Traktor Setup.....	18
Panel Drawings.....	20
Introduction .....	21
Rear Connectors .....	22
MIDI Controls .....	25
MIDI Control Section .....	27
MIDI Shift Mode.....	28
Input Chanel 5/6 .....	29
BPM Section.....	30
Monitor Section .....	32
Block Diagram .....	33
Specifications.....	34

# PACKED ITEMS

Check that you have received the following:



Xone:2D Professional Digital Music Interface

Check that the rear panel optical in/out blank plugs are fitted.



Safety Sheet

**Important !** Read this sheet before starting. Retain for future reference.

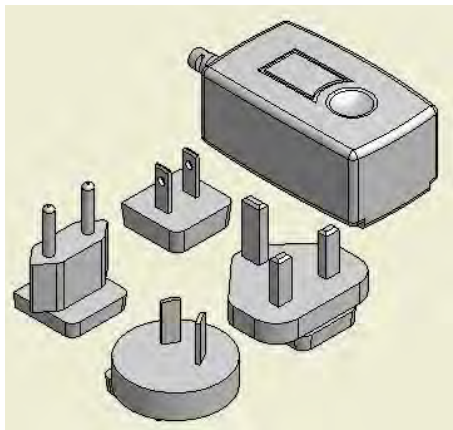

Power Supply

Fit the correct mains adaptor for your region.

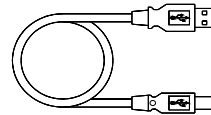

Type A-B USB Lead

To connect the Xone:2D to your computer.



Registration Card

Complete and return to Allen & Heath to register your product.

## POWER SUPPLY

The Xone:2D contains its own Universal Voltage Input Power Supply unit with interchangeable heads for territory specific mains electricity outlets.

The power supply comes with a pin protector that needs to be removed before the desired head can be fitted.

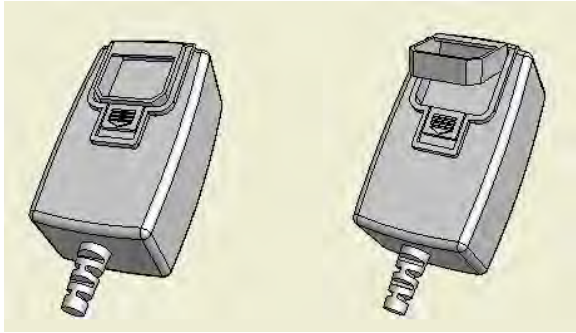

To remove the pin protector, pull down on the release mechanism and pull the protector out from the bottom.

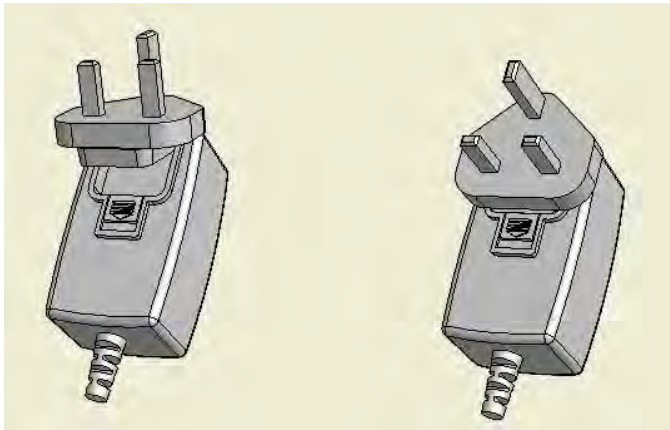

To attach the required head, locate at the top first and then push down to locate and lock in the release mechanism.

# SOFTWARE INSTALLATION PC

## STOP!

BEFORE YOU DO ANYTHING WITH YOUR XONE:2D, PLEASE READ THE FOLLOWING CAREFULLY TO ENSURE YOUR PC IS CORRECTLY SET UP TO BE USED WITH THE DEVICE.

### Software Installation (Windows 2000, XP and Vista)

Follow the procedure described below to install the USB audio and MIDI drivers:

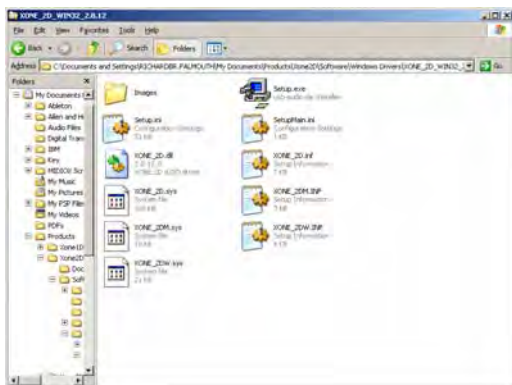

1— Using the provided power supply, connect the Xone:2D to your mains electricity supply.

**Do not connect the 2D to the PC at this time.**

2— Download the latest drivers from [www.xone.co.uk/2D](http://www.xone.co.uk/2D), and run DRIVERS setup.

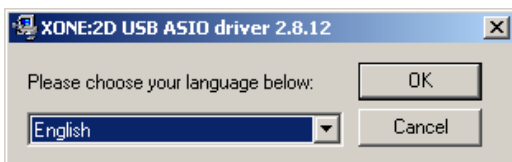

3— Select your preferred language

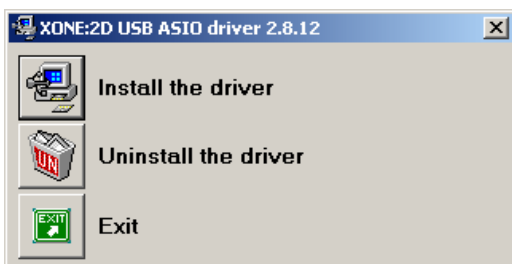

4— Select “Install the driver”

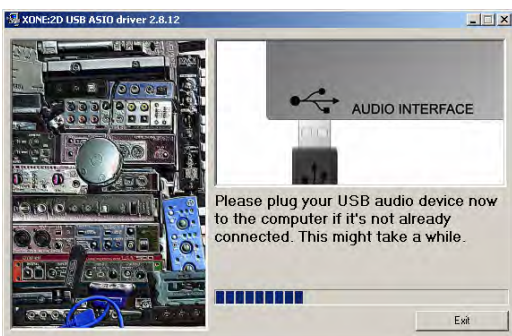

5— When prompted, connect the 2D to the PC with the USB lead.



The audio device will now initialise.



# SOFTWARE INSTALLATION PC



6— You will now be asked to unplug your Xone:2D



7— You will now be asked to plug in your Xone:2D again.

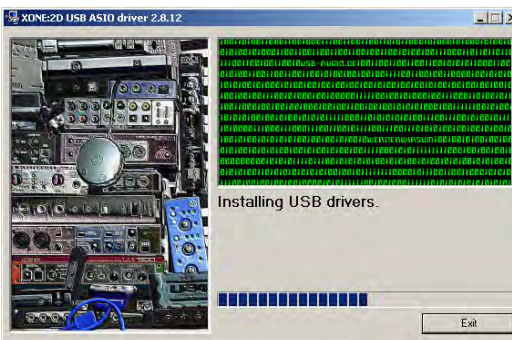

The USB drivers will now initialise.

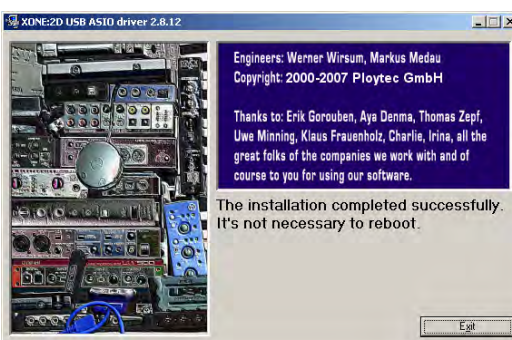

8— The driver installation will complete without reboot (XP, Vista) or ask you to reboot your PC (Win 2000).

**Note: Always use the same USB port with your Xone:2D.** When installing on a MS Windows system, the drivers will be associated with the USB port that you are currently plugged into. If you attempt to use the 2D with another USB port, or without installing the drivers at all, the system may work but with degraded performance (XP, Vista), or may not work at all (2000).

# CHECKING THE DRIVER INSTALLATION—WINDOWS

## Checking the Driver Installation

Once the driver installation is complete, you will need to check that the Xone:2D is being recognised. To do this, connect the Xone:2D to your PC/laptop and then right click on **My Computer** to open the **System Properties** window.

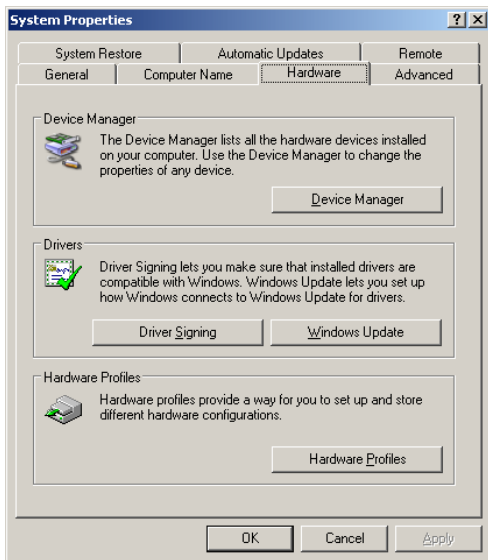

Select the **Hardware** tab then click on **Device Manager**

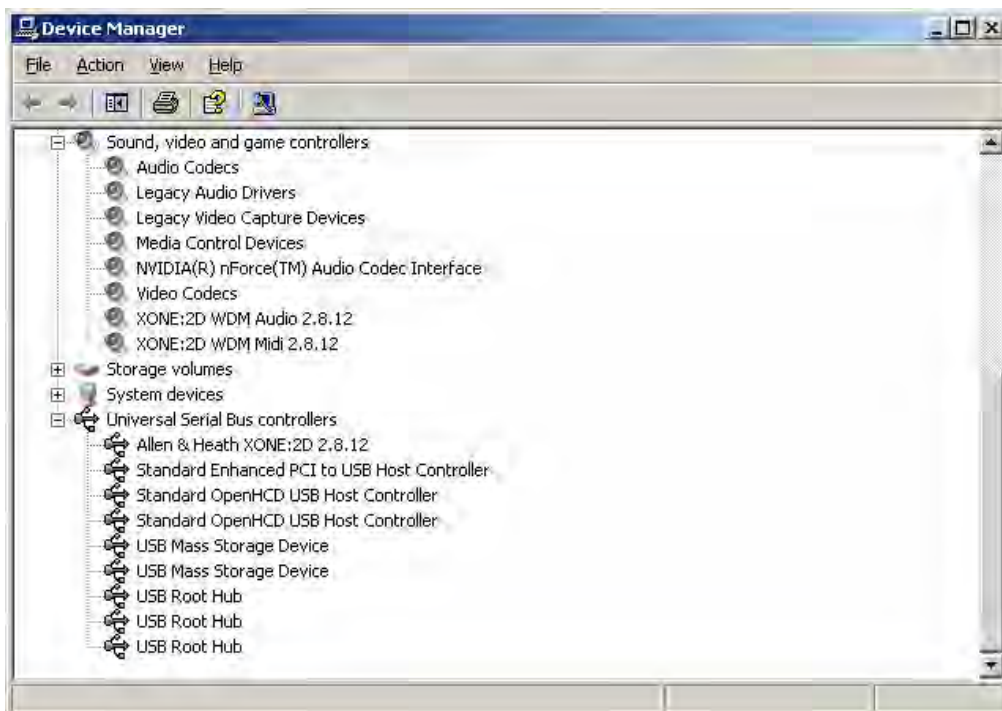

Expand the **Sound, Video and Game Controllers** section to reveal the WDM audio and MIDI drivers for the Xone:2D.

Expand the **Universal Serial Bus Controllers** section to reveal the Xone:2D ASIO driver and its release (version) number—in this case V2.8.12.



# SOFTWARE INSTALLATION—APPLE MAC

## STOP!

BEFORE YOU DO ANYTHING WITH YOUR XONE:2D, PLEASE READ THE FOLLOWING CAREFULLY TO ENSURE YOUR PC IS CORRECTLY SET UP TO BE USED WITH THE MIXER.

### Mac OS X

Download the latest drivers from [www.xone.co.uk/2D](http://www.xone.co.uk/2D). Open the Xone\_2D\_Driver\_x.x.x.dmg to reveal the window shown.

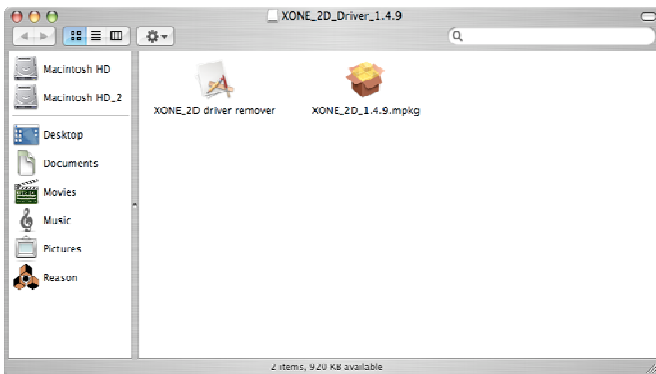

Click on the Xone:2D mpkg file to launch the driver installation.

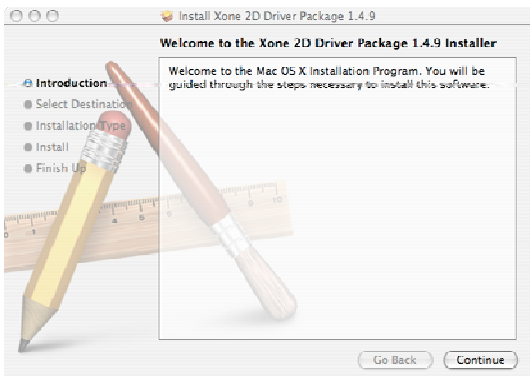

Click on “Continue”.

Select install destination and then click “Continue”.

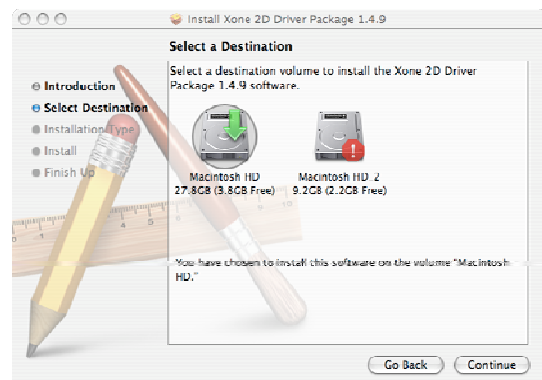

Click on “Upgrade”.

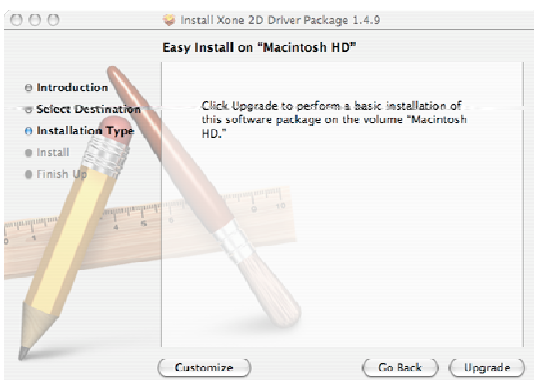

# SOFTWARE INSTALLATION—APPLE MAC



Enter your system password.



Click on “Continue Installation”.

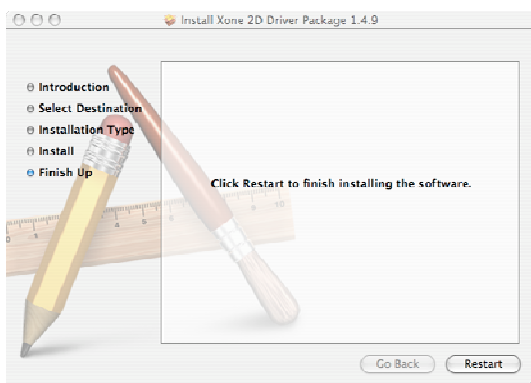

Restart your Mac.

# CHECKING THE DRIVER INSTALLATION—APPLE MAC

## Checking the Driver Installation

Once the driver installation is complete, you will need to check that the Xone:2D is being recognised. To do this, connect the Xone:2D to your Mac and then select:

Mackintosh HD → Applications → Utilities → Audio MIDI Setup

Now select the Audio tab and in the “**Properties For**” dropdown box select Allen & Heath Xone:2D.

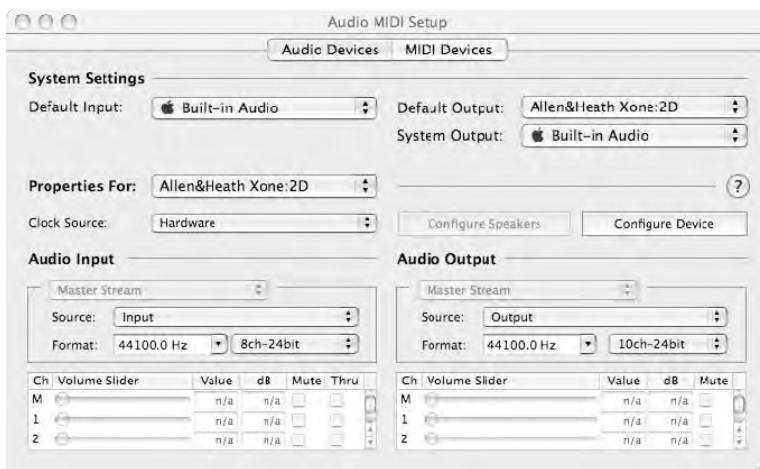

In the **Audio Input** section, the number of channels should be seen as 8, running at 24 bit.

In the **Audio Output** section, the number of channels should be seen as 10, running at 24 bit.

The sample rate is selectable from 44.1 to 96kHz.



Now select the **MIDI Devices** tab and make sure that the Xone:2D is seen as a MIDI device as shown.

# MIDI CHANNEL SETUP

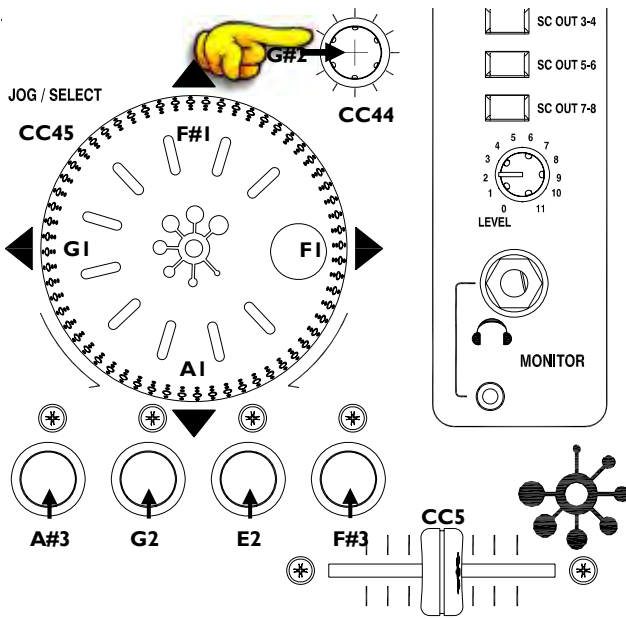

## MIDI Channel Number

The MIDI channel number will default to channel 16, but can be changed to any channel between 1 and 16.

To change the MIDI channel number and MIDI map:

1. Hold down the switch on the encoder shown in the diagram
2. Connect the Power Supply to the Xone:2D
3. At the end of the start up sequence, when the illuminated switches have flashed three times, release the switch on the encoder.

The illuminated switches on the Xone:2D will display the current MIDI channel

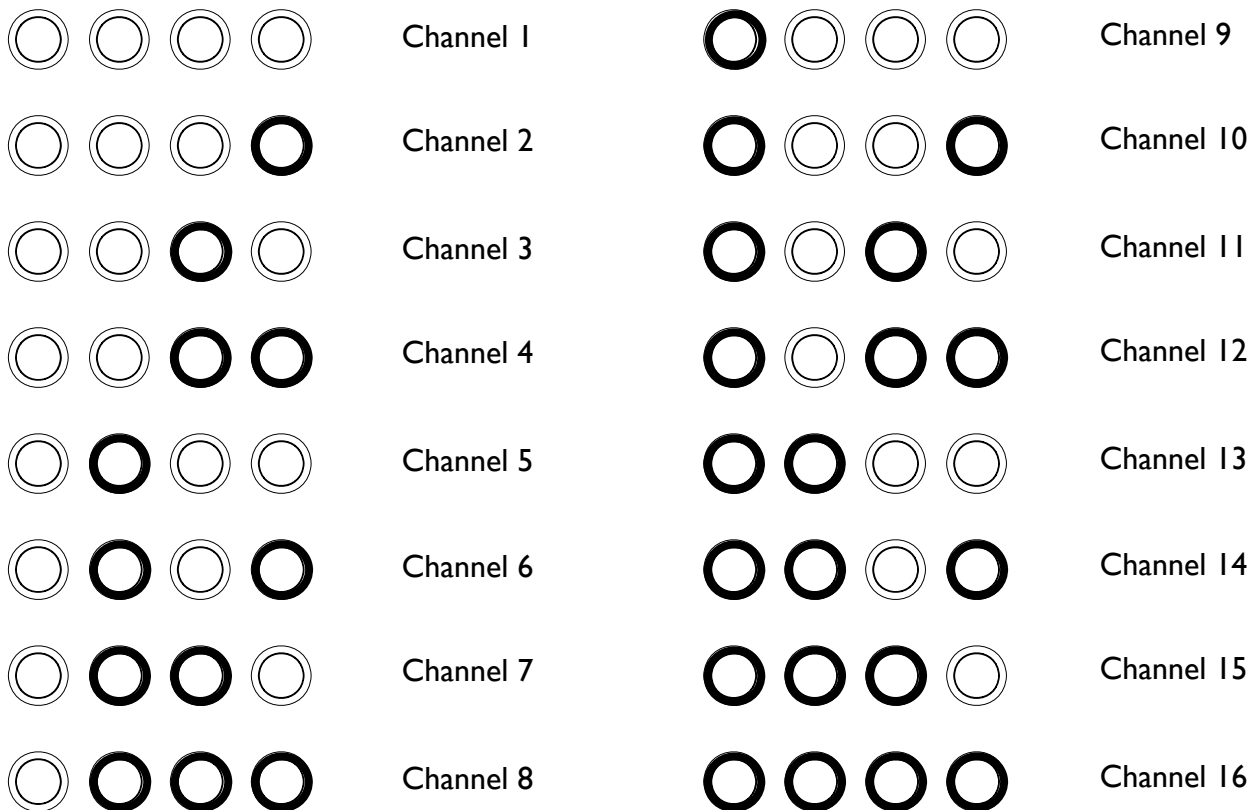

To change the channel number that the MIDI is transmitted on, rotate the encoder above the jog wheel.

Once the desired channel has been selected, press and then release the switch on the encoder above the jog wheel, the illuminated switches will flash once indicating that the channel number has been set.

# MIDI MAP AND LIGHT PIPE SETUP

## Changing the MIDI Map

Once the MIDI channel number has been stored, the illuminated switch to the far right of the unit will flash indicating that the MIDI map may now be selected.

### Map 1 (Traktor default)

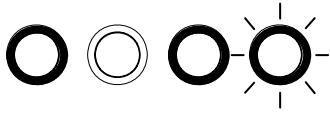

The first switch (far left) is used to select MIDI Map 1. In this map the top row of encoders send 'Note On' messages upon rotation (see **MIDI Control Section p25**).

The third button (centre right) is used to determine the status of the light rings. If the third light ring is illuminated, then during normal operation all four light rings will stay illuminated at all times.

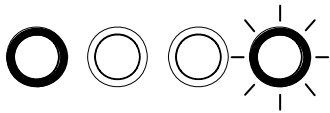

If the third light ring is not illuminated then each light ring will toggle on and off on receipt of a specific MIDI 'Note On' message. The 'Note On' message that the light ring responds to is the same 'Note On' message that is sent by the corresponding switch. Therefore, referencing the **MIDI Control Section**, the first (far left) light pipe will toggle on and off when it receives a 'Note On' message of A#3.

### Map 2 (Ableton default)



The second switch (centre left) is used to select MIDI Map 2. In this map the top row of encoders send 'Control Change' messages upon rotation (see **MIDI Control Section p25**).

The third button (centre right) is used to determine the status of the light rings. If the third light ring is illuminated, then during normal operation all four light rings will toggle on and off when their respective switch is pressed.

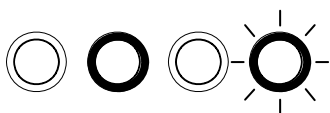

If the third light ring is not illuminated then each light ring will toggle on and off on receipt of a specific MIDI 'Note On' message. The 'Note On' message that the light ring responds to is the same 'Note On' message that is sent by the corresponding switch. Therefore, referencing the **MIDI Control Section**, the second (middle left) light pipe will toggle on and off when it receives a 'Note On' message of G2.

When the desired MIDI map has been selected, press and release the switch on the encoder above the jog wheel. The illuminated switches will flash three times indicating that the MIDI map has been stored and that the unit is now in its normal operating mode.

# USING THE DIGITAL I/O

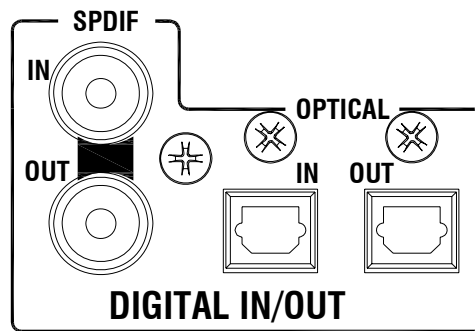

## Digital In

A digital input to the Xone:2D can be connected using either the COAX (RCA-type) connection or the OPTICAL (TOSLINK) connection. The embedded software scans the digital inputs and auto-senses which one is active.

When an external digital audio device is connected via the digital inputs, the system sample rate will be locked to the sample rate of the digital audio source. This can crash software applications if they are open when the digital input is connected.

To safeguard against this situation, connect your digital input in the following sequence:

1. Power down the Xone:2D
2. Connect the digital input device
3. Power up the Xone:2D
4. Open your music software application

## Digital Out

The digital output of the Xone:2D can be connected to external equipment using either the COAX (RCA-type) connection or the OPTICAL (TOSLINK) connection—the digital signal is present on both.

The sample rate of the digital audio out is determined within the settings of your music software application (Ableton, Traktor etc.), up to a maximum frequency of 96kHz. When recording using an external digital recorder, match the system sampling rate to the recording sample rate set on the external device.



# SOUNDCARD ROUTING

## Architecture

The Xone:2D has a built-in 18-channel soundcard. The inputs and outputs of the soundcard are of fixed architecture.

<b>Soundcard Input</b>	<b>Ableton Descriptor</b>	<b>Traktor Descriptor</b>
1-2 (Phono / Line)	1/2 (Stereo) 1 (Mono) & 2 (Mono)	Xone 2D Analogue In 1 Xone 2D Analogue In 2
3-4 (Phono / Line)	3/4 (Stereo) 3 (Mono) & 4 (Mono)	Xone 2D Analogue In 3 Xone 2D Analogue In 4
5-6 (Line / Mic)	5/6 (Stereo) 5 (Mono) & 6 (Mono)	Xone 2D Analogue In 5 Xone 2D Analogue In 6
7-8 (Digital in 1-2)	7/8 (Stereo) 7 (Mono) & 8 (Mono)	Xone 2D Digital In 1 Xone 2D Digital In 2

<b>Soundcard Output</b>	<b>Ableton Descriptor</b>	<b>Traktor Descriptor</b>
1-2 (RCA Phono)	1/2 (Stereo) 1 (Mono) & 2 (Mono)	Xone 2D Analogue Out 1 Xone 2D Analogue Out 2
3-4 (RCA Phono)	3/4 (Stereo) 3 (Mono) & 4 (Mono)	Xone 2D Analogue Out 3 Xone 2D Analogue Out 4
5-6 (RCA Phono)	5/6 (Stereo) 5 (Mono) & 6 (Mono)	Xone 2D Analogue Out 5 Xone 2D Analogue Out 6
7-8 (RCA Phono)	7/8 (Stereo) 7 (Mono) & 8 (Mono)	Xone 2D Analogue Out 7 Xone 2D Analogue Out 8
9-10 (Digital Out 3-4)	9/10 (Stereo) 9 (Mono) & 10 (Mono)	Xone 2D Digital Out 3 Xone 2D Digital Out 4

## Supported Buffer Sizes

The Xone:2D supports the following buffer sizes:

64, 96, 128, 192, 256, 384, 512, 768, 1024 etc.

## NOTE:

**To maintain the optimum functionality of your software please ensure that you have the latest version installed. Also ensure that you are using the correct configuration files for the software release.**

# ABLETON SET UP

Launch your Ableton software and open the **Preferences** window.

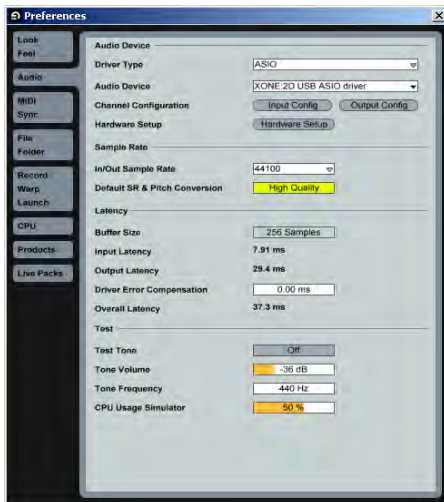

1— In the '**Preferences**' window select the '**Audio**' tab. Once the 2D is connected, change the driver type to '**ASIO**' and set the Audio Device to '**Xone:2D USB ASIO driver**'

In the '**Settings**' section click on the '**Input Config**' button.

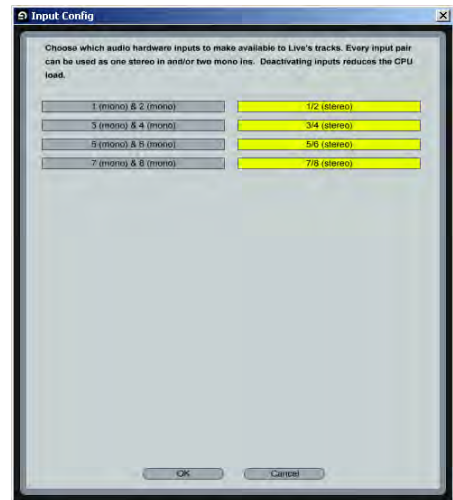

2— Select the '**Stereo**' options and de-select the '**Mono**' options. You must click '**OK**' for the changes to take effect.

Now, in the '**Settings**' section of the '**Audio**' tab, click on the '**Output Config**' button.

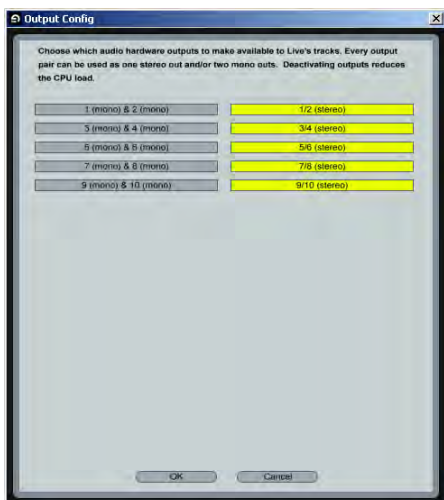

3—Select the '**Stereo**' options and de-select the '**Mono**' options. You must click '**OK**' for the changes to take effect.

Now select the **MIDI Sync** tab of the **Preferences** window.

4— Set the **Track**, **Sync** and **Remote** to '**On**' for the Xone:2D MIDI Input and Output.

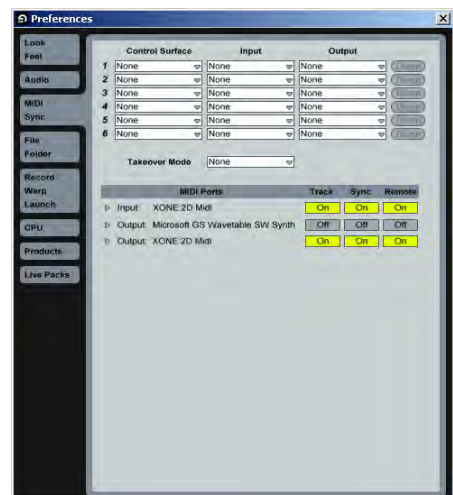

# ABLETON SET UP

To load a live set in Ableton select:

File → Open Live Set

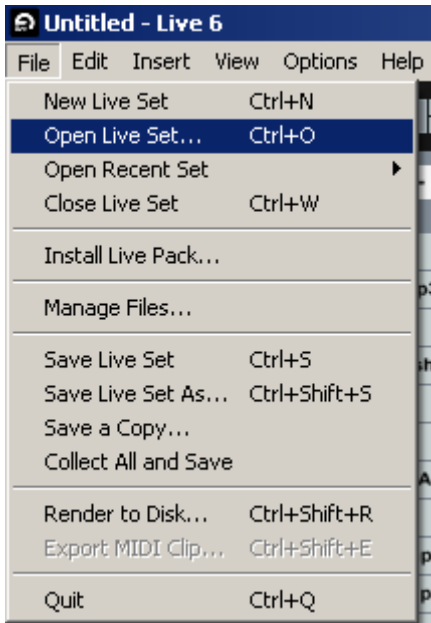

Select the required .als file once the Open dialogue box appears:

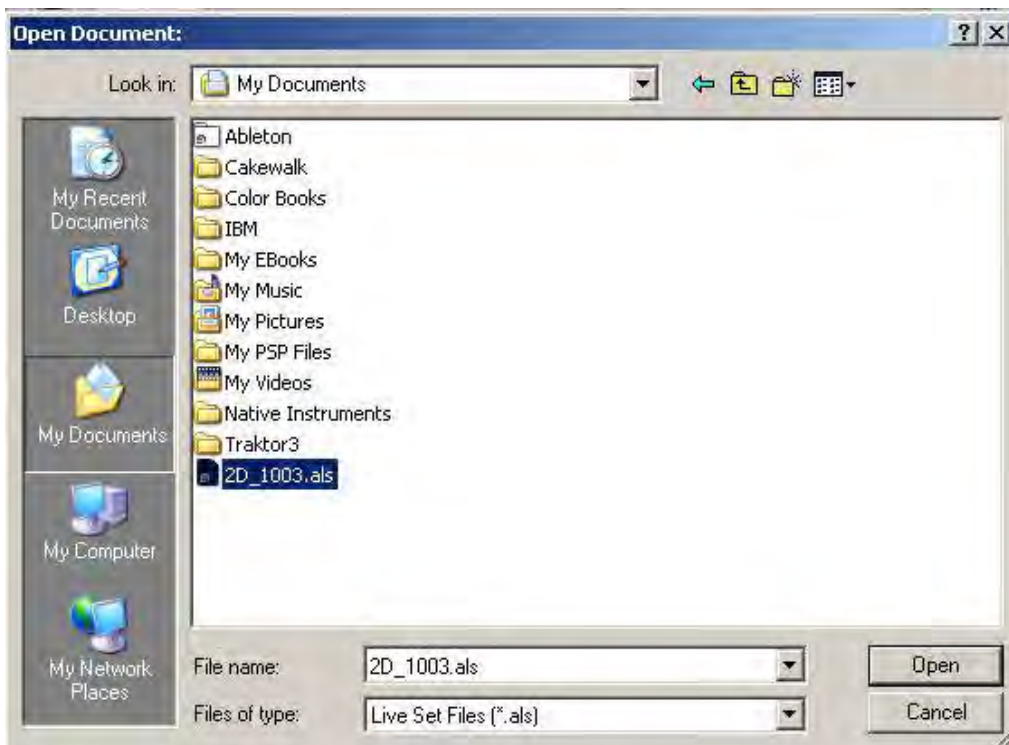

# TRAKTOR SET UP

Launch your Traktor software and open the **Preferences** window.



1— In the '**Preferences**' window expand the '**Audio Setup**' section and select '**Soundcard**'. Set the Audio Device to '**Xone:2D USB ASIO driver**'

Now select '**Input Routing**'.

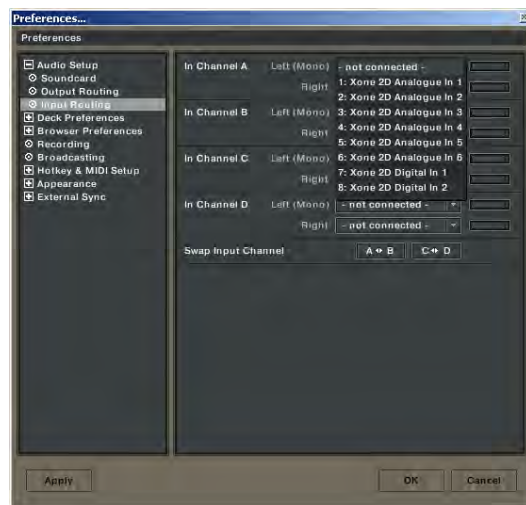

2— In the '**Input Routing**' section, assign the Xone:2D analogue or digital inputs to the required deck.

Now select '**Output Routing**'.



3— In the '**Output Routing**' section, first make sure that the **Mixer Mode** is set to '**External**'. Now assign the Xone:2D analogue or digital outputs to the required deck.

4— In the '**Preferences**' window expand the '**Hotkey & MIDI Setup**' section, select '**MIDI Interfaces**', double click the '**Active**' box next the Xone:2D MIDI and an '**X**' will appear. This will activate the MIDI from the Xone:2D.



# TRAKTOR SET UP

To load a .tks file in Traktor:

In the Preferences window, select **MIDI Setup**. At the bottom of the window select **Load**.

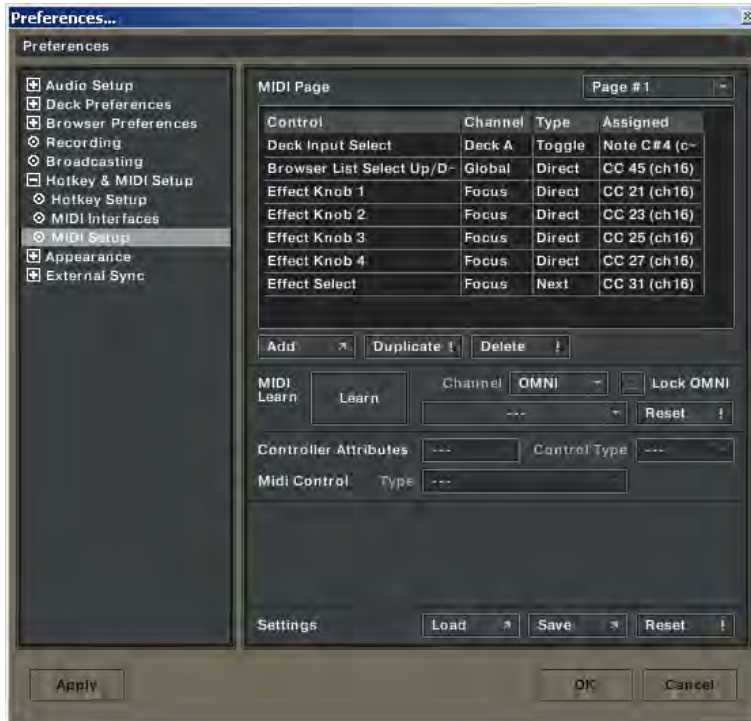

Select the required .tks file once the Open dialogue box appears:

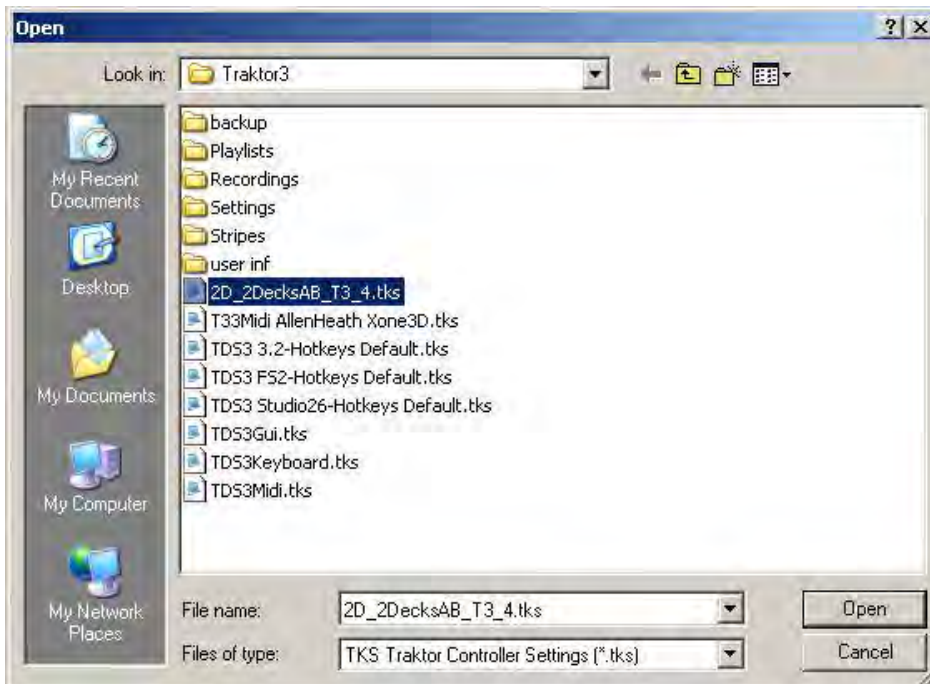

# PANEL DRAWINGS

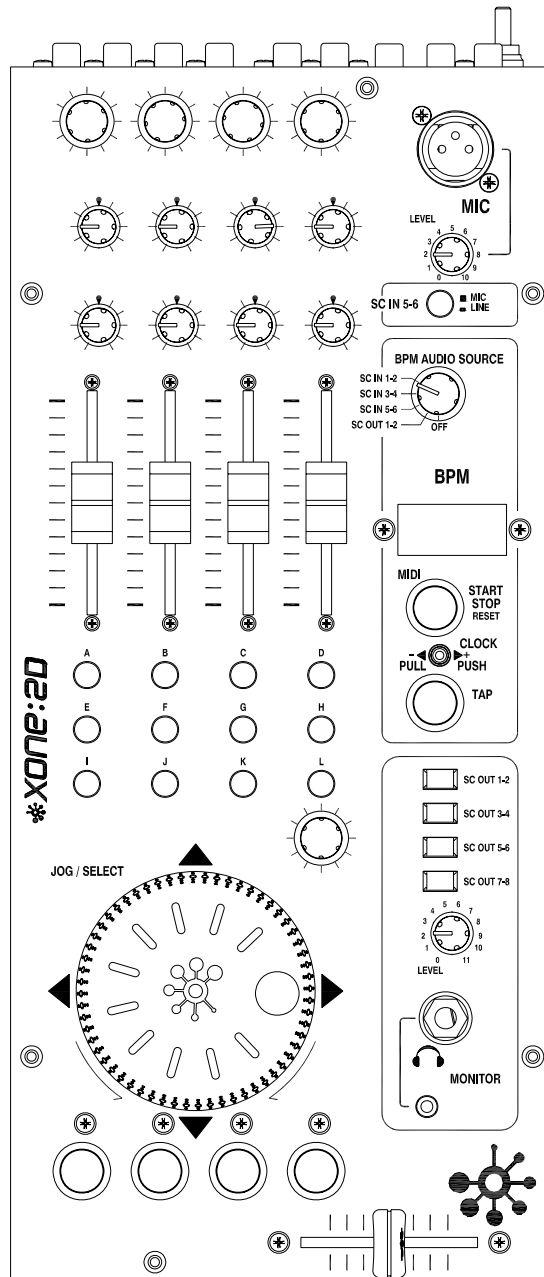
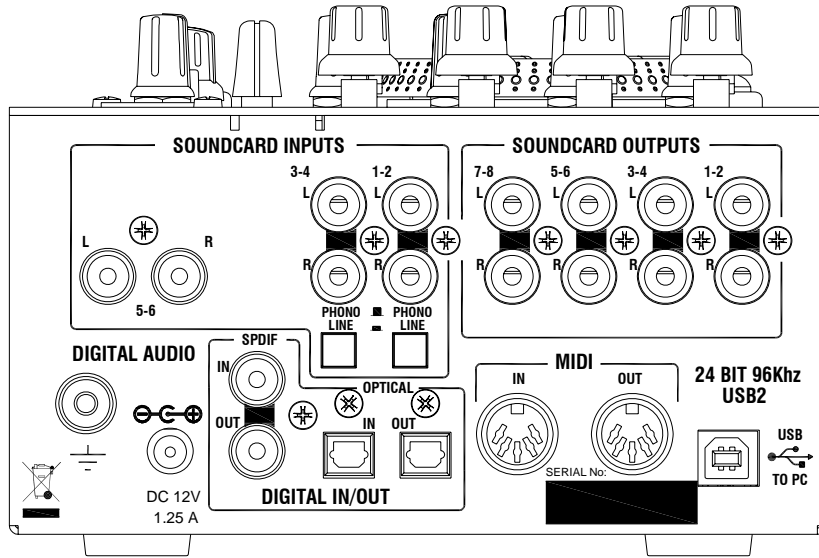



# INTRODUCTION TO THE XONE:2D

Welcome to the Allen & Heath Xone:2D Professional Digital Music Interface. This system has been designed with the help of some of the world's most cutting edge DJs to provide a seamless integration of computer-based audio replay systems. The Xone:2D comprises three main sections:

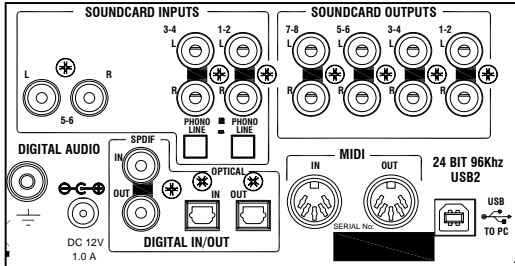

**BPM COUNTER**— The BPM counter is based on the award winning Allen & Heath Xone:3D. The BPM Section features Auto BPM Detection, Tap Tempo, sequencer remote 'Start/Stop' facility and a lever for 'Pushing' or 'Pulling' the generated MIDI Timing Clock.

**MIDI CONTROLLER**— The dedicated control strip provides a total of 87 MIDI messages across two layers. The MIDI controls are a combination of switches, rotary and fader controls, a multi-function jog wheel and a cross-fader. The Xone:2D provides full control of external MIDI devices including the most sophisticated DJ performance computer environments.

**SOUNDCARD**— The Xone:2D soundcard has a total of 18 channels transmitted via USB2.0. Eight input channels (6 analogue and 2 digital) and ten output channels (8 analogue and 2 digital) provide high quality 96kHz 24-bit audio transfer.

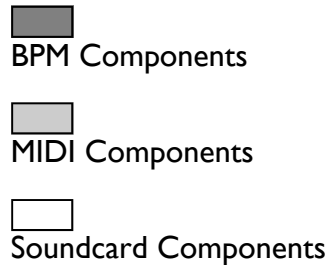
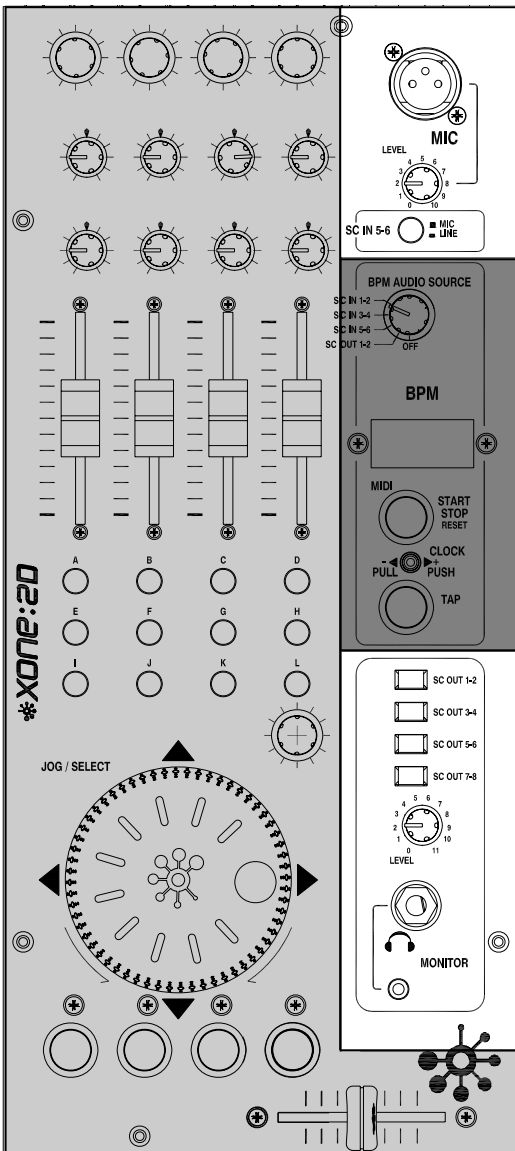

# REAR CONNECTORS

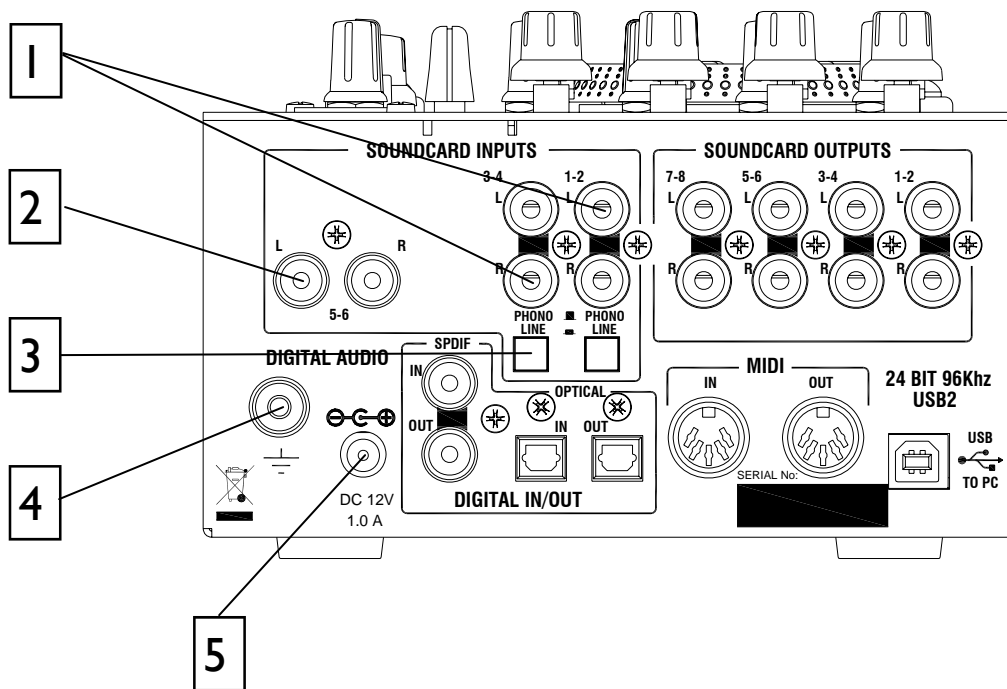

1

## SOUNDCARD INPUTS 1-2, 3-4

RCA Phono sockets for connection to Soundcard Input Channels 1-2 and 3-4.

2

## SOUNDCARD INPUT 5-6

RCA Phono sockets for connection to Soundcard Input Channels 5-6. The source for Soundcard Input 5-6 may also be the microphone as selected on the front panel.

3

## SOUNDCARD INPUTS PHONO / LINE SELECT

Switch for selecting between Phono and Line inputs for Soundcard Input Channels 1-2 and 3-4. Select 'Line' for line level inputs such as CD Players, or 'Phono' for turntables that require RIAA equalisation.

4

## CHASSIS EARTH TERMINAL

A screw terminal is provided for connecting the earth straps from turntables. This connection earths the metal parts of the turntable to reduce hum, buzz or similar audible noise getting into the system.

5

## DC INPUT SOCKET

Connect the supplied external power supply to this socket.

# REAR CONNECTORS

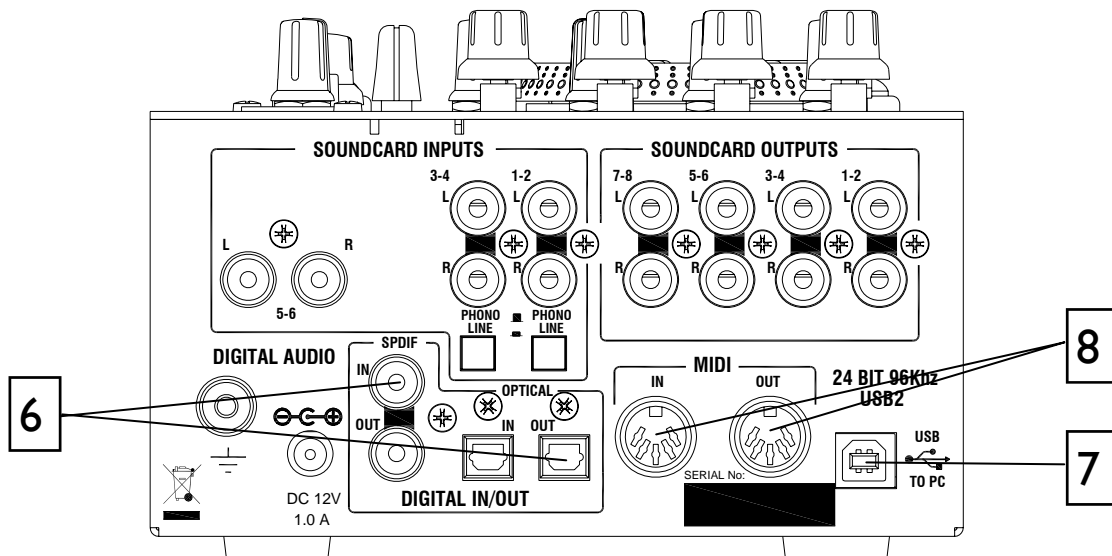

## 6 SPDIF DIGITAL INPUTS AND OUTPUTS

SPDIF is a popular digital audio interfacing standard for connecting two channel (stereo) audio using a single COAX (RCA phono socket) or OPTICAL (TOSLINK socket) cable.

For reliable connection use a 75 ohm COAX cable intended for this function. Avoid the use of cheap audio cables. Use purpose made optical fibre cables for connection using the Toslink port. Make sure the blanking plugs provided are fitted to any unused Toslink sockets.

The SPDIF inputs and outputs are available only when your computer is connected via the USB port. The computer provides the clocks needed for the soundcard to function.

Sample rates of 44.1, 48 and 96kHz are supported with the ability to interface with any digital source up to 192kHz.

## 7 USB Connector

USB (Universal Serial Bus) V2.0 is an external peripheral interface standard for data transmission. Xone:2D USB works at 480Mbps and provides up to 18 uncompressed audio channels.

The USB connection is used to send/receive audio and MIDI data between the Xone:2D and the connected computer. Use a standard USB type A to B lead to connect to your computer. This is supplied with the Xone:2D.

## 8 MIDI IN / OUT

Connect to either a MIDI interface or directly to MIDI compatible equipment using a standard 5 pin DIN (MIDI) lead. The MIDI output socket data duplicates what is sent via the USB connection to the PC.

Incoming MIDI is merged with the Xone:2D MIDI and transported, via USB, to the PC or Mac. Incoming MIDI data can also be used to remotely control the status of LED light rings (with the exception of the Tap Tempo and Stop/Start.)

You can connect the MIDI OUT of one Xone:2D to the MIDI IN of another.

# REAR CONNECTORS

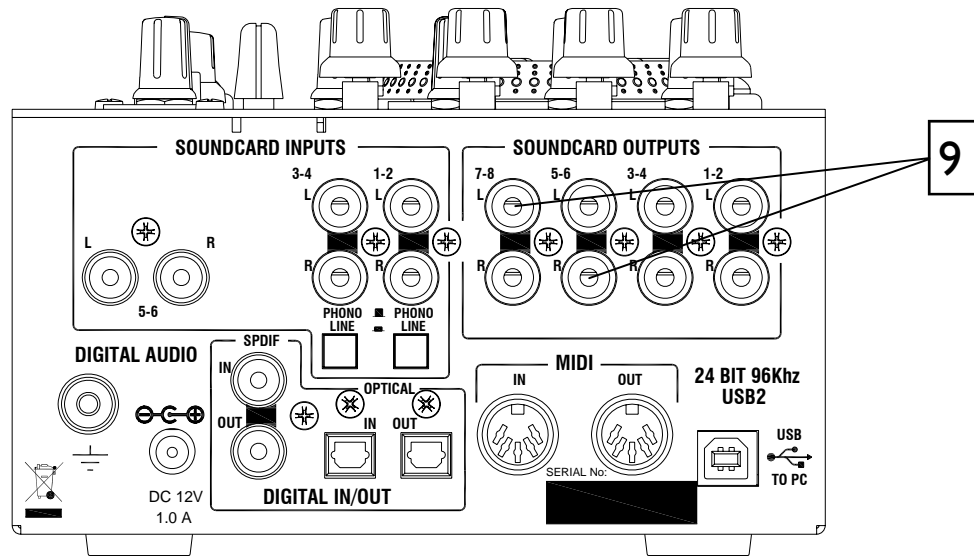

## 9 SOUND CARD OUTPUTS

RCA Phono sockets are provided for interfacing with the analogue audio outputs of the Xone:2D soundcard. The soundcard outputs are grouped in pairs:- 1/2, 3/4 etc.

# MIDI CONTROLS

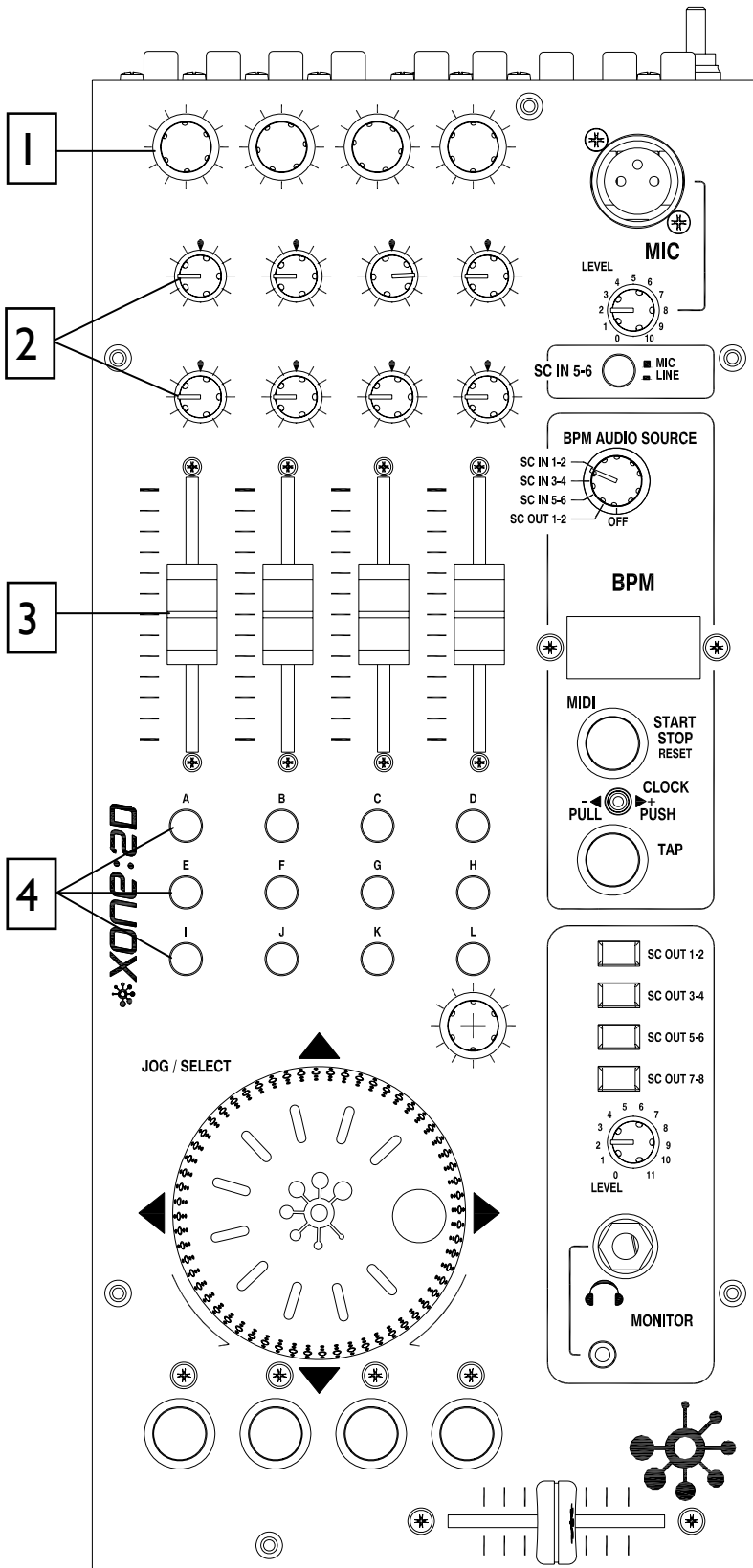

## 1 Rotary Encoders

Turning an encoder produces MIDI CC (continuous controller) messages with a unique controller number in 'Two's Complement' binary encoding. Refer to the **MIDI CONTROL SECTION** (p25) for the differences between Map 1 and 2 for these controls.

These encoders feature a built in momentary push switch. Pressing down on the encoder knob activates the switch and sends a 'Note On' MIDI message, releasing the switch sends a corresponding 'Note Off' message.

## 2 Rotary Potentiometers

These controls are standard potentiometers with end stops and a centre detent for easy setting. Turning a pot from left to right will send MIDI messages with a unique CC number and a control value from 0 to 127.

## 3 Linear Faders

Moving a linear fader will send a MIDI message with a unique CC number and a control value from 0 (bottom) to 127 (top).

## 4 Push Buttons

There are 24 momentary action switches coded with letters A through X for easy identification. Pressing a switch will send a unique 'Note On' MIDI message. Releasing the switch sends a corresponding 'Note Off' message.

# MIDI CONTROLS

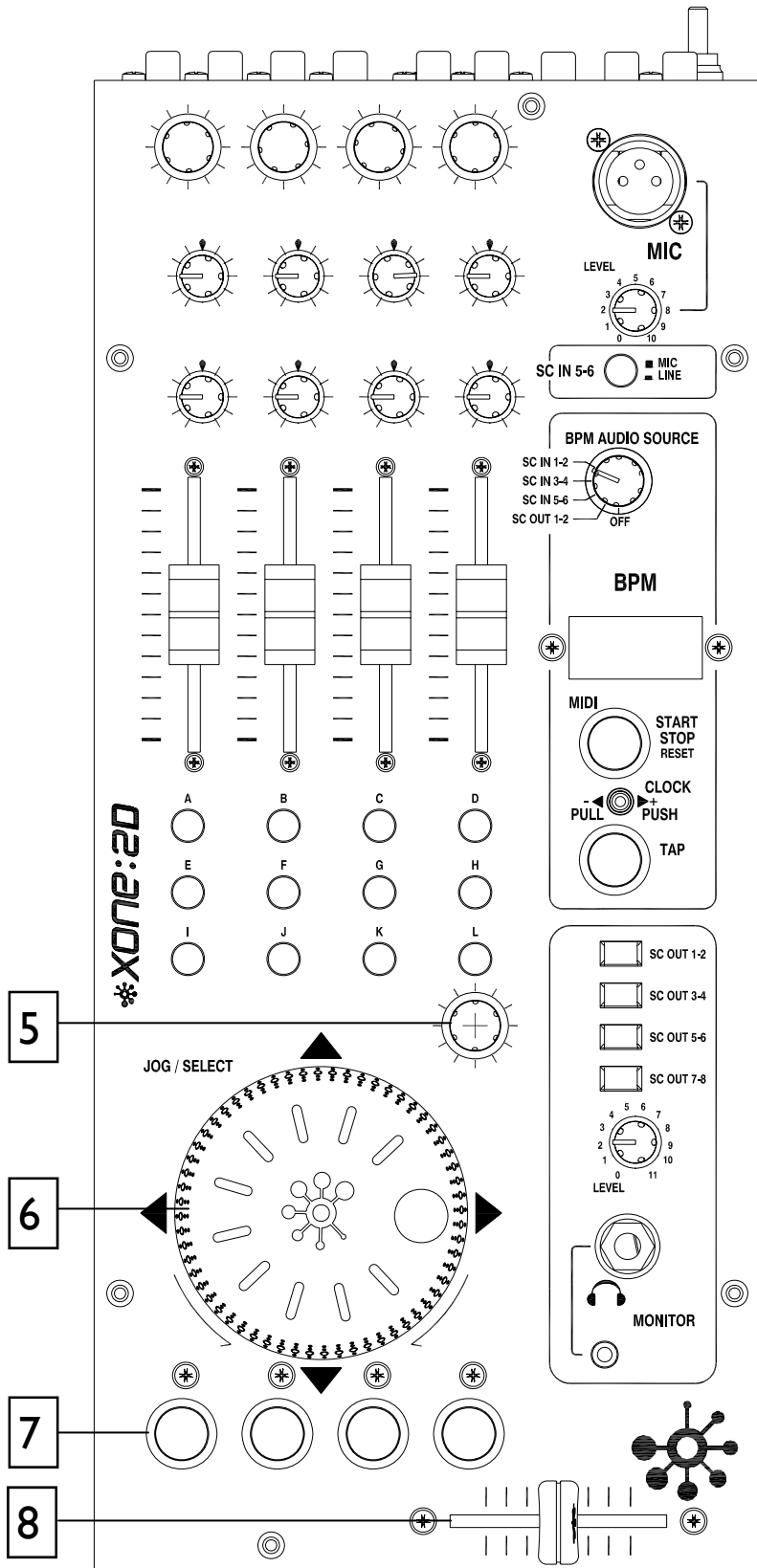

**5 Rotary Encoder**  
A rotary encoder with switch, as previously described.

**6 Jog Wheel**  
The jog wheel features an optical encoder, which produces CC messages in a similar way to the other encoders. Switches are located at the top, bottom, left and right of the wheel. Pushing down on the face of the wheel sends 'Note On' / 'Note Off' messages.

**7 Illuminated Push Buttons**  
Momentary action switches with red light ring indicators. Control of these indicators depends upon system setup. Please refer to **MIDI MAP AND LIGHT PIPE SETUP** (p13).

**8 Cross Fader**  
Moving the cross-fader will send a MIDI message with a unique CC number and a control value from 0 (fully left) to 127 (fully right).



# MIDI CONTROL SECTION

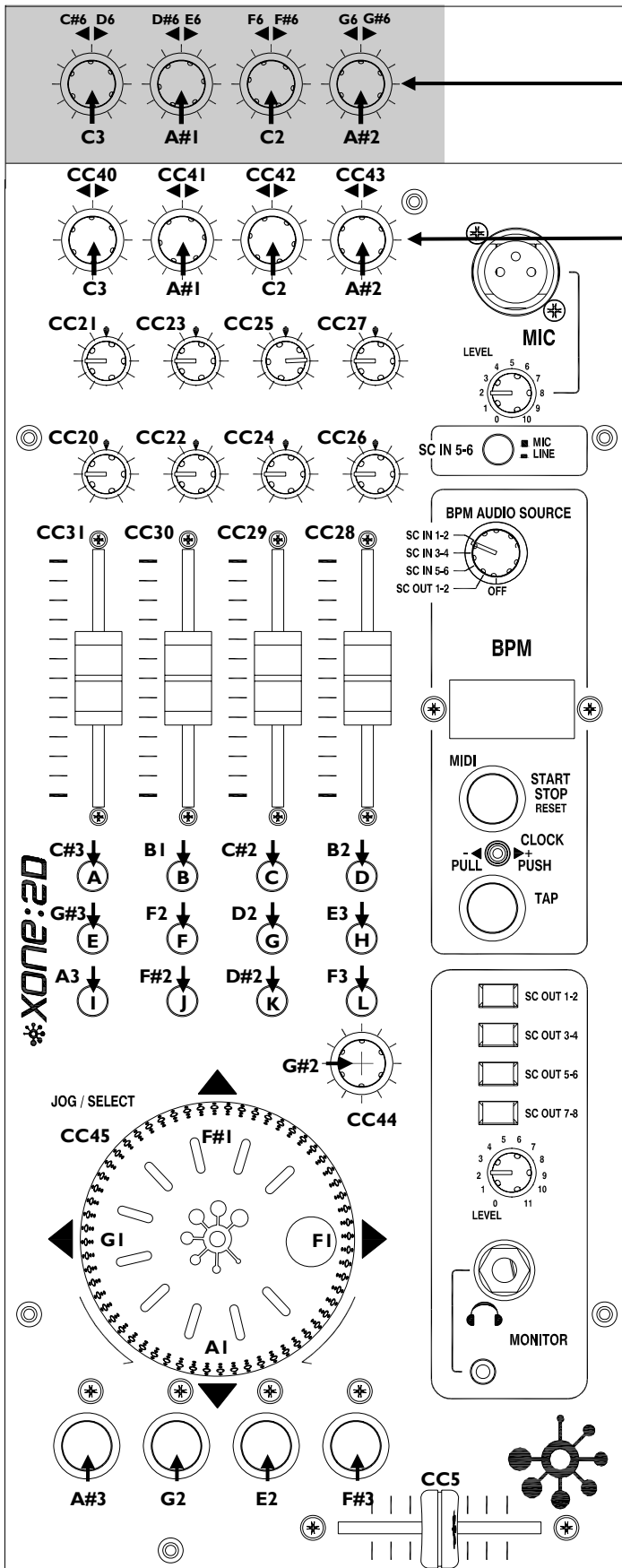

MAP 1

MAP 2

## MIDI Map

Two control mappings are available, Map 2 is the default for most applications. Map 1 differs only in the messages generated by the top row of rotary encoders and the four illuminated switches. Use Map 2 with Ableton Live software. Map 1 is recommended for use with Native Instruments Traktor software.

## MIDI Messages

The diagram shows which controls are associated with MIDI CC (continuous controller), 'Note On' and 'Note Off' messages. These controls send the MIDI messages shown when operated.

The rotary encoders and jog wheel are digital controls that send 'Two's Complement' data rather than absolute values. For a more in depth description of how to set up the MIDI controls please refer to the Technical Tutorials on the Xone website:

[www.xone.co.uk](http://www.xone.co.uk)

The switch light ring indicators may be turned on or off by incoming MIDI messages.

# MIDI SHIFT MODE

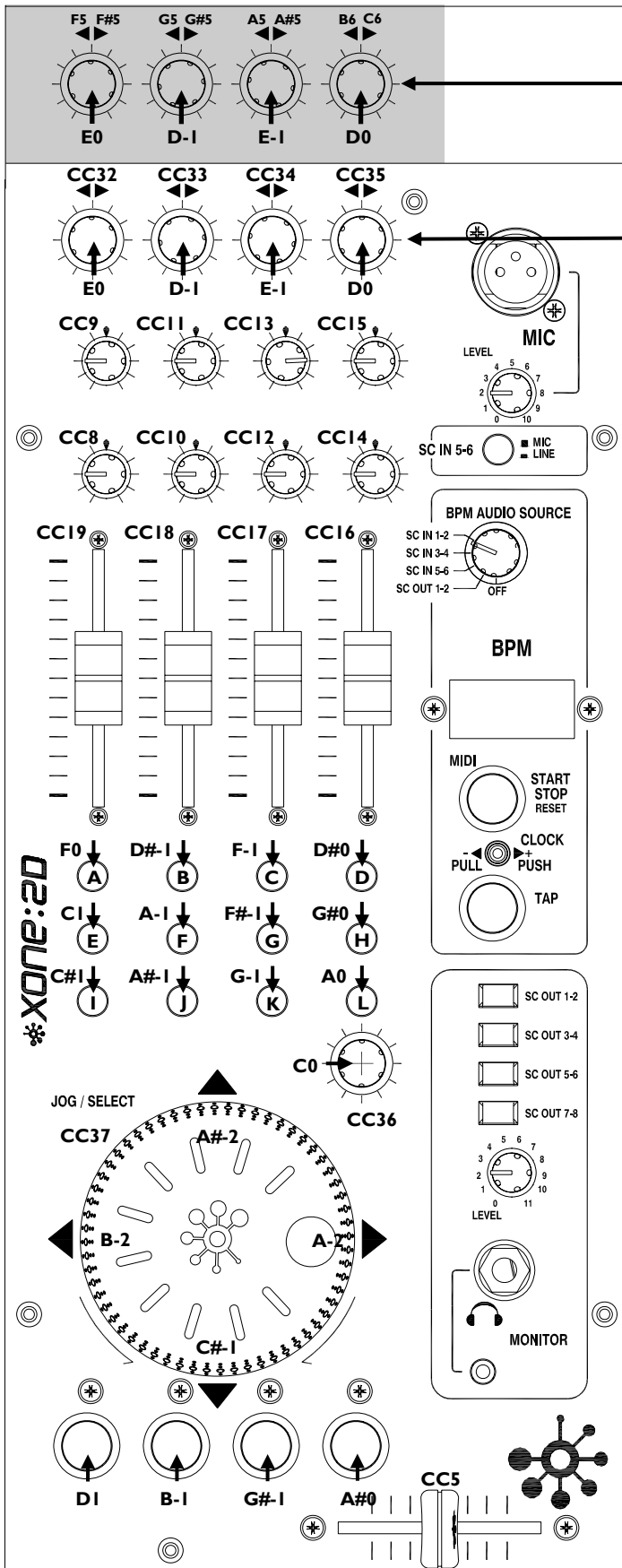

MAP 1

MAP 2

## Shift Mode

To enter MIDI Shift Mode, press and hold (for approximately 0.5 seconds) the encoder above the jog-wheel until the BPM display shows 'SFT'. The Xone:2D is in Shift Mode whilst 'SFT' is displayed and sends the messages as shown.

The Xone:2D employs a fader 'pick up' algorithm so that controls do not jump suddenly when used between the two layers.

To exit Shift Mode press and hold the encoder again.

## NOTE:

For logical operation, the cross-fader will send the Control Change message CC5 regardless of which layer is selected.

## INPUT CHANNEL 5/6

The input to Soundcard channel 5/6 can be either a Mic or Line source. The line source is connected via RCA Phono connectors and the Mic source is via a female XLR3 socket.

Input channel 5/6 should be used for devices with a low output level such as MP3 players, as the level control can be used to boost the signal level when the selector switch is in the 'LINE' position. The level control adjusts the microphone input level when the selector switch is in the 'MIC' position.

Devices with output levels above  $-10\text{dB}$  should be connected to either Soundcard Input 1-2 or Soundcard Input 3-4.

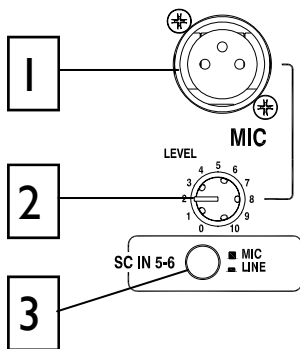

- 1 MIC Input Socket**  
Female XLR3 connector for microphones
- 2 Level Control**  
The level control is used to amplify the incoming signal whether it is a Mic or a Line source.
- 3 MIC / LINE Selector**  
Selects between Mic or Line input to Soundcard Input 5-6

## BPM SECTION

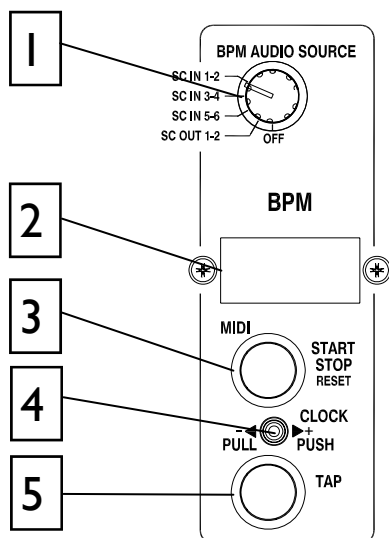

### 1 BPM Audio Source Selector

This five position switch allows the source to the BPM detection software to be changed between any of the three stereo Soundcard inputs or Soundcard output 1-2. It also has an 'OFF' position if beat detection is not required.

### 2 BPM Display Window

Displays the analysed or tapped BPM. When the Xone:2D is powered up, the display will indicate the version number of the firmware within the unit.

The display will show **SFT** when in shift mode.

### 3 MIDI Start/Stop Reset

Sends MIDI start/stop messages to any connected sequencer. Note that these messages are sent on release of the switch. Pressing and holding this switch will reset the auto BPM detector, but won't change the current status of the Stop/Start control.

Pressing and holding this switch for approximately five seconds will turn off the Xone:2D internal MIDI clock and the BPM display will change to OFF. Press and hold the STOP/START button again until the three dashes are displayed to reset the BPM and turn the MIDI clock back ON

The LED ring associated with this control will glow RED when a Start message is sent, and will also turn ON/OFF when a MIDI STOP/START/PAUSE command is received from an external MIDI device connected to the MIDI IN socket of the Xone:2D

### 4 MIDI Clock Push / Pull Switch

When attempting to get a sequencer, such as Ableton Live, to play in time with another music source, for example a CD or turntable which has been analysed by the auto beat detector, it is not always possible to get it to start exactly at the beginning of a bar. This control lets the DJ speed up or slow down the MIDI clock, rather like pushing or pulling a turntable platter when beat matching.

Pulling the lever to the left will slow the clock and the BPM reading will drop, pushing the lever to the right will speed up the clock and the BPM reading will rise.

When released, the MIDI clock will revert to the originally displayed BPM.

You can manually set the BPM to any speed between 70 and 400 by pulling or pushing the lever; when the desired speed is indicated on the display, press the TAP button to lock the MIDI clock to this speed. To fine tune the BPM to an exact figure, press and hold the TAP button and when the decimal point is displayed, the speed can be altered by 0.1BPM again by using the Push/Pull lever.

# BPM SECTION

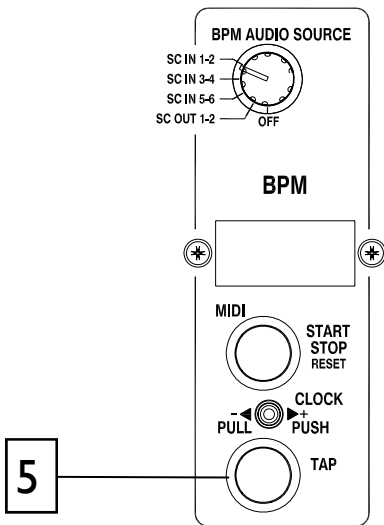

5

## BPM Tap Tempo Button

This control is used to tap in a beat manually at any speed between 70 and 400 BPM. The taps are averaged, so the greater number of taps the more accurate the result.

The tap button can also be used as a guide for the auto beat detector on complex rhythms by helping the analyser lock onto the correct pattern; for instance, drum 'n bass tracks can occasionally be displayed at half the actual BPM. By tapping in the approximate beat the analyser will re-sync to the correct tempo.

Pressing and holding the tap tempo button shifts the BPM display one place to the left so that the decimal can be shown.

When the BPM is being speeded up or slowed down using the push/pull lever, pressing the tap button will store the currently displayed tempo.

The light ring associated with this control will flash in time with the current BPM speed, usually along with the kick drum, though occasionally the detector will synchronize to other rhythmic elements of a track such as a hi-hat line. This will not affect its accuracy. Tapping a few beats in manually will force the detector to re-sync to the beat.

# MONITOR SECTION

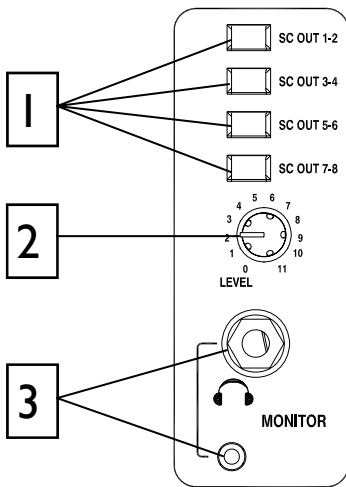

1

## Soundcard Output Selector

Latching switches are used to select Soundcard outputs 1-2, 3-4, 5-6 and 7-8. When all switches are in the 'UP' position, no signal will be sent through the headphone outputs. Selecting any switch will route the relevant Soundcard output to the monitor section. If more than one switch is selected, all of the relevant Soundcard outputs will be routed to the headphone outputs.

2

## Headphones Level Control

Adjusts the level of the headphones signal.



**Warning !** To avoid damage to your hearing do not operate the headphones or sound system at excessively high volume. Continued exposure to high volume sound can cause frequency selective or wide range hearing loss.

3

## Headphones Outputs

Stereo 1/4" TRS jack and 3.5mm mini-jack. Plug in good quality stereo headphones intended for DJ monitoring. Use closed-ear headphones that provide maximum acoustic isolation when cueing your sources. We recommend that you use high quality headphones rated between 30 to 100 ohms impedance. 8 ohm headphones are not recommended.

# BLOCK DIAGRAM

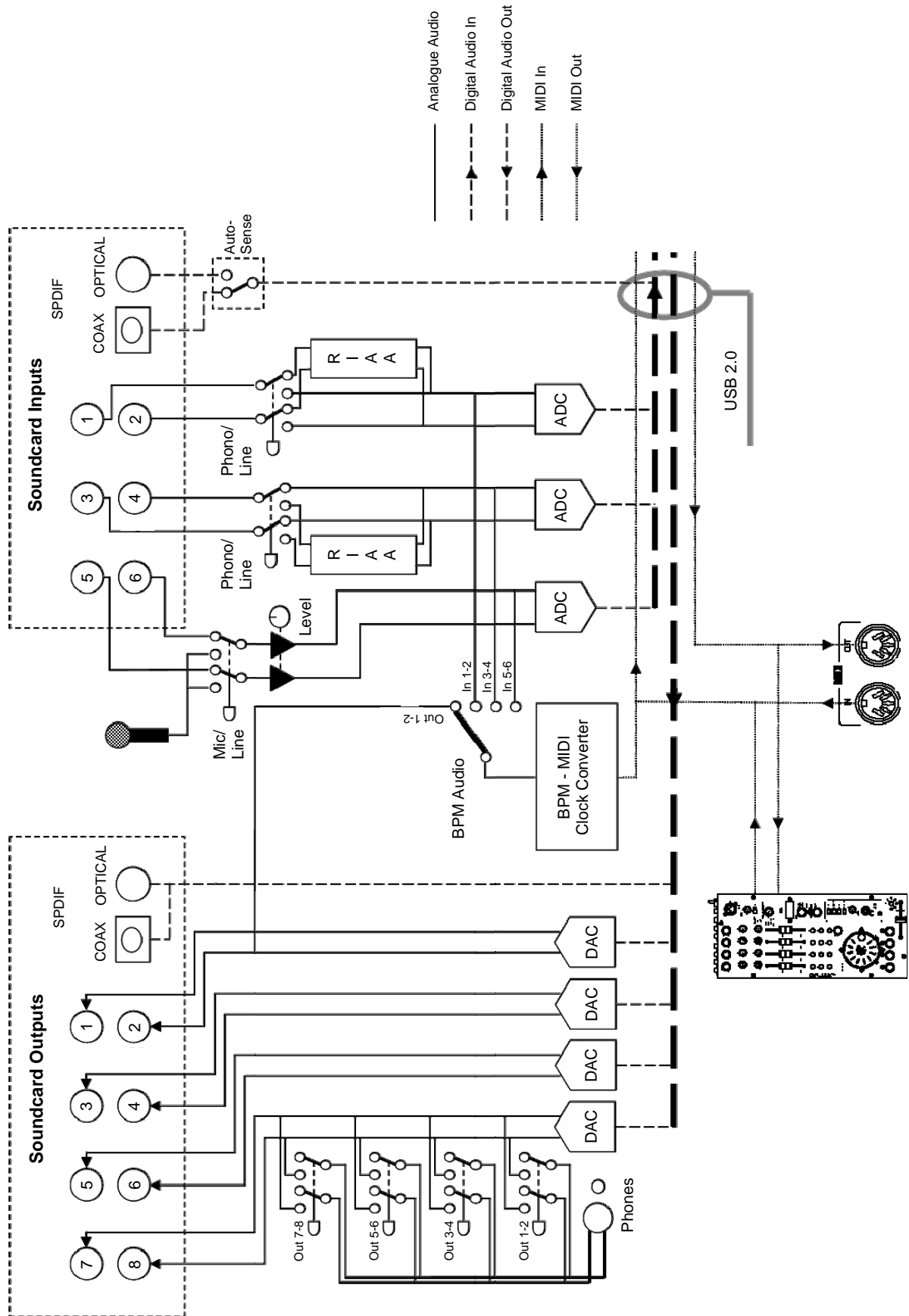

# SPECIFICATIONS

Frequency Response SC in to SC out	10 Hz to 20kHz +0/-0.5dB
96kHz Sample Rate	10 Hz to 36kHz +0/-3dB
THD + N Line In to Line Out +8 dBu	< 0.008%
Maximum Output Level	+9dBu
Maximum Input Level	+9dBu
Dynamic Range Output	104dB
System Dynamic Range Line In to Line Out	94dB
Mic Sensitivity	-50dBu to -30dBu
Input 5-6 Sensitivity	-3 to +22 dB
RIAA Input Sensitivity	7-48mV 1KHz/330pF

## Dimensions and Weights

The console is fitted with rubber feet for desktop operation.

	Width	Height	Depth	Weight
Desktop	160 mm (6.3")	88 mm (3.5")	358 mm (14")	2kg (4.4 lbs)
Packed	304 mm (12")	195 mm (7.7")	475 mm (18.7")	4.5kg (10 lbs)

