

ATX WIRE COLOUR CODE

+3V3	=ORANGE
+5V	=RED
+12V1	=YLW
+12V2	=YLW/BLK STRIPE
-12V	=BLUE
PG	=GREY
STBY	=PURPLE
GNDS	=BLACK

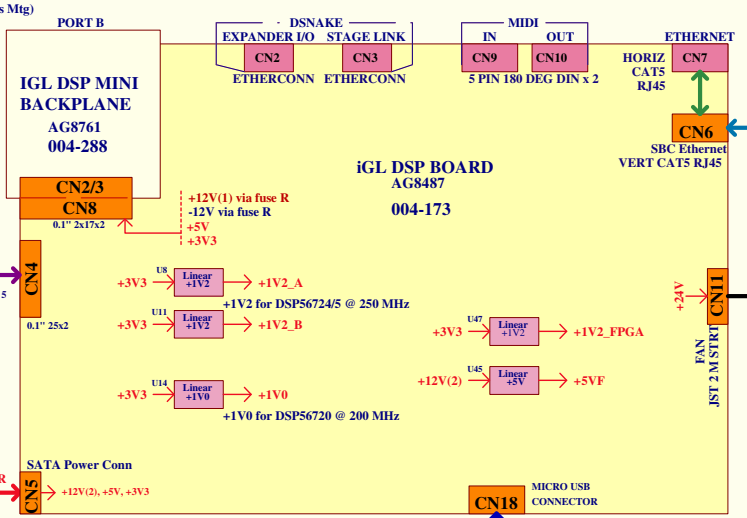
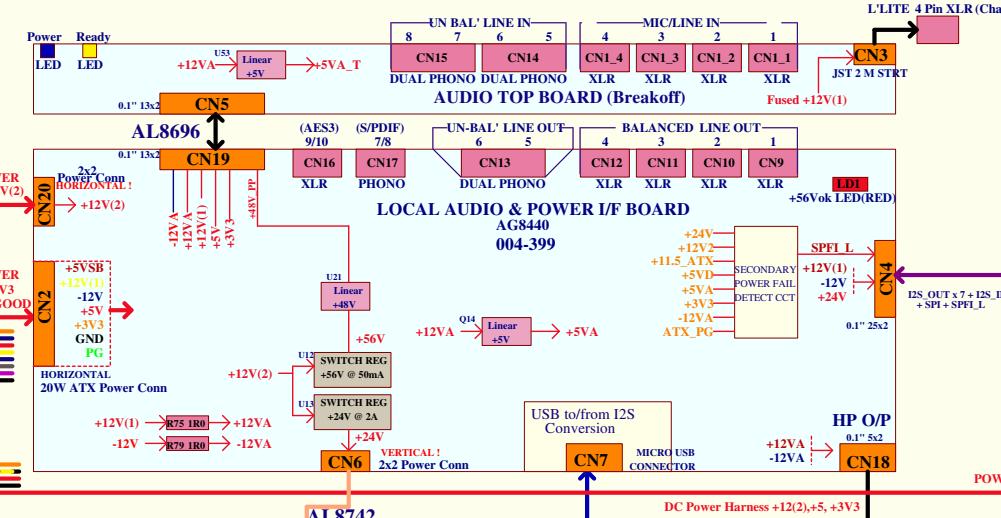
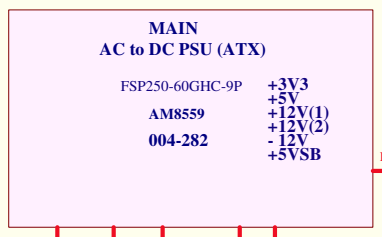

REAR BASE

TOP SURFACE

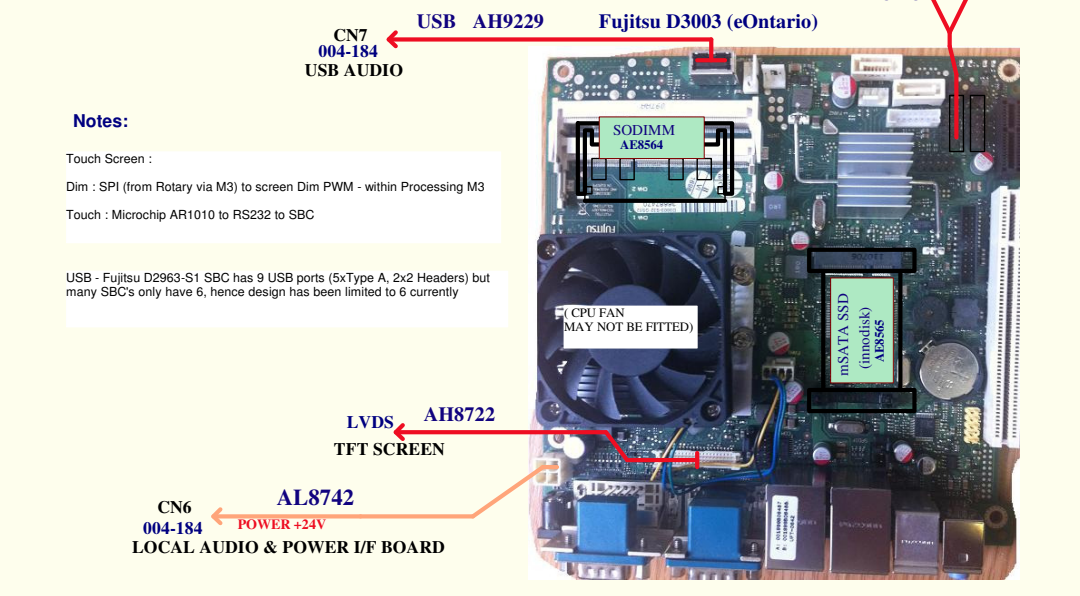
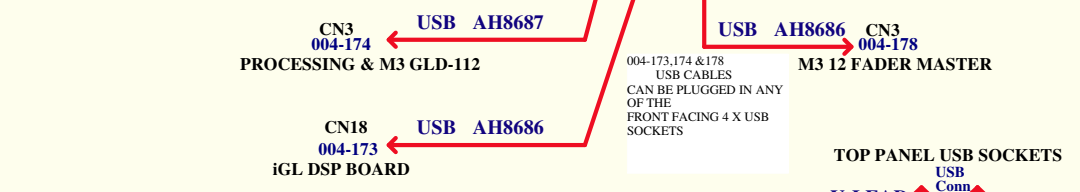
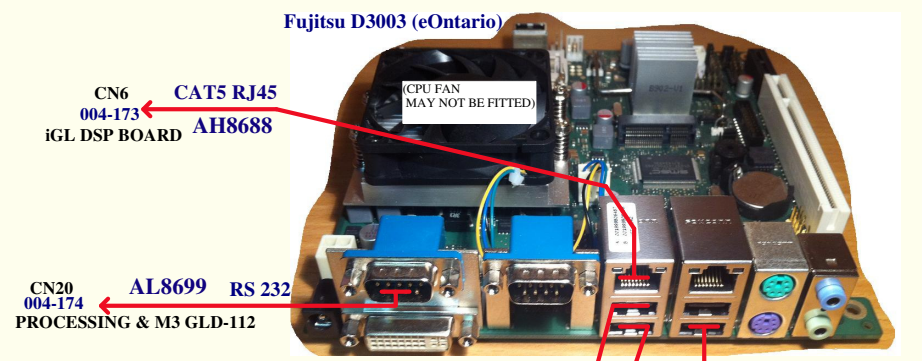
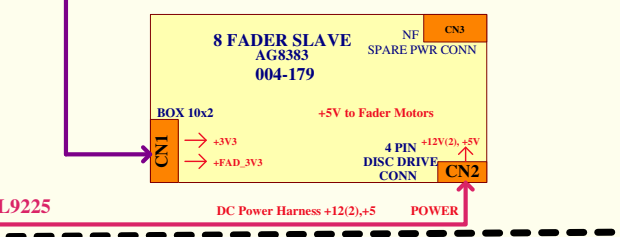
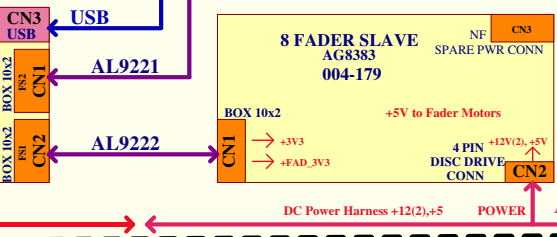
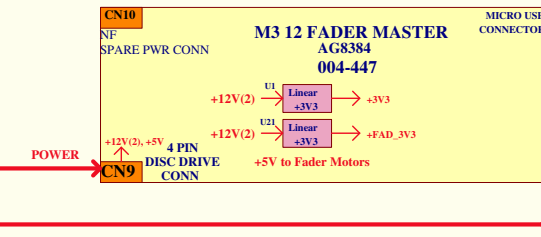
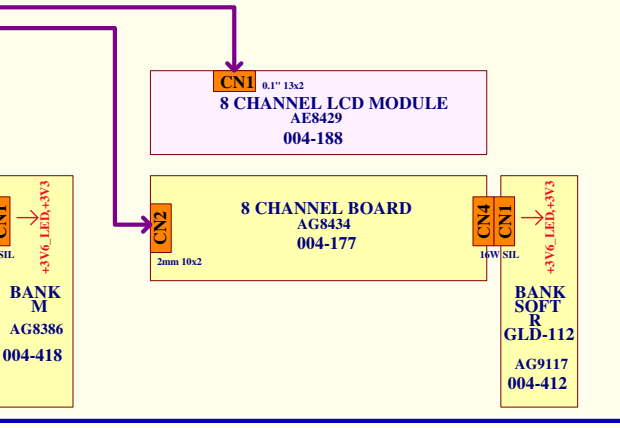
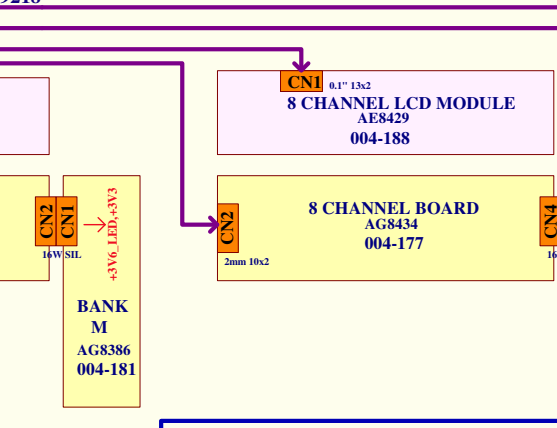
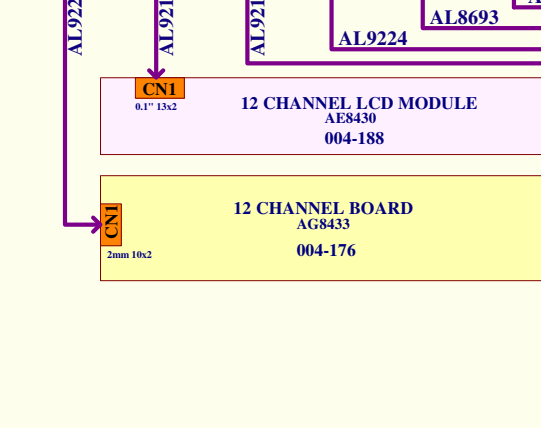
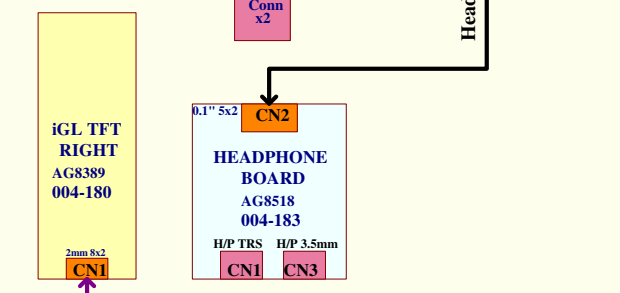
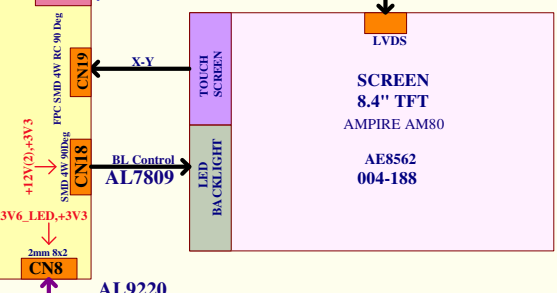
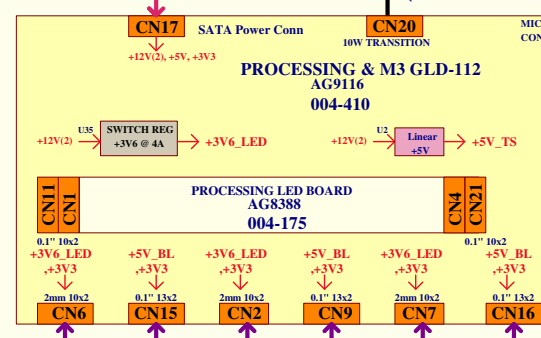
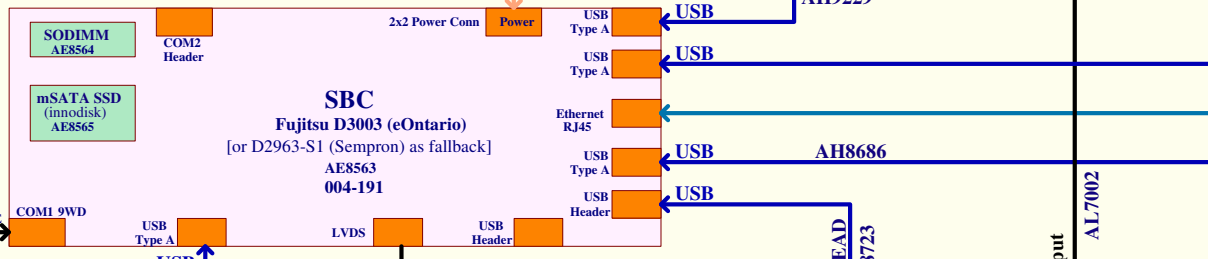

ALLEN & HEATH
Kernick Industrial Estate,
Penryn, Cornwall,
England. TR10 9LU
Tel: +44 (0)1326 372070
Fax: +44 (0)1326 370153

ISSUE	BY	DATE	CHK BY
A	AG	14/03/13	
B	KV	13/06/13	
C	KV	27/06/13	

GLD-112 BLOCK DIAGRAM, CONNECTIVITY CHART & POWER DISTRIBUTION
FOR ALLEN & HEATH INTERNAL USE ONLY

FILE: GLD-112_Block_Diagram.SPD
PRINTED: 11:48:36 23/10/2013

TITLE: XXXX XXXX XXXX
PAGE:
DRG No: CXXXX ISSUE: XX SHEET: 1 OF 1

* All parts to be RoHS Compliant