

Applications Note

SYS-LINK explained

SYS-LINK (system link) is the Allen & Heath connection standard for linking two consoles together to expand the number of input channels feeding the mixes. One becomes the 'slave' to the other 'master' console. All the slave console mix busses including main LR, groups and auxes connect directly to the master console mix busses without using up valuable input channels. The PFL/AFL system is also linked so that all channels can be monitored using the master console headphones and meters. The slave console master section is not used as its signals are taken before the mix inserts and output faders. Both consoles must have the SYS-LINK option fitted. A single multiway cable is all that is required to link the **WZ³** to another Allen & Heath console fitted with SYS-LINK.

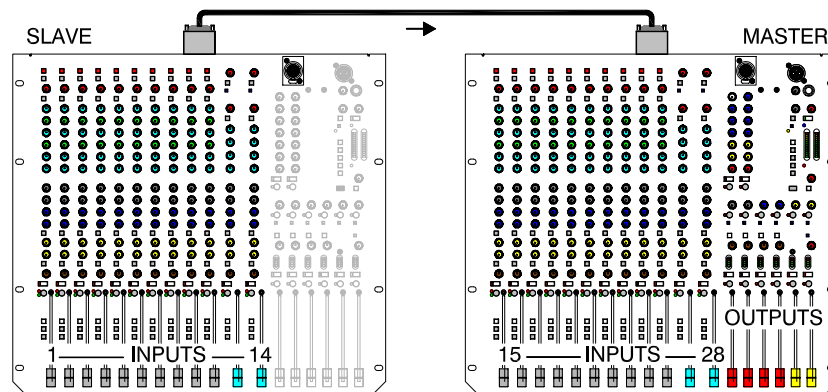

SYS-LINK versions 1 and 2

The **MixWizard WZ³** uses the more recent SYS-LINK Version 2 standard. This benefits from balanced interconnections which allow longer cable length with less chance of noise and interference pickup than the earlier, unbalanced SYS-LINK Version 1. Both versions operate at -2dBu line level. V1 uses the 25way D-type connector. V2 uses the 37way D-type connector. Two consoles fitted with SYS-LINK V2 can be linked using a 36-core shielded cable wired one to one to two 37way male D-type connectors. It is also possible to connect between SYS-LINK V2 and V1. This requires a 37way to 25way adapter cable wired to unbalance the connections. Wiring details are provided later. The interconnecting cable is not included in the kit and should be sourced elsewhere or ordered separately from Allen & Heath.

WZ³16:2 / WZ³12:2 / WZ³20S SYS-LINK V2 output option

Option kit W312/16-SLV2 is available from Allen & Heath. This can be installed in the **WZ³16:2**, **WZ³12:2** or **WZ³20S** console to provide a SYS-LINK V2 output connection. Note that an input connection is not provided. These consoles may be used as 'slave' channel expanders only. For information on fitting the option refer to document AP5735.



WZ³14:4:2 SYS-LINK V2 input and output option

Option kit W31442-SLV2 is available from Allen & Heath. This can be installed in the **WZ³14:4:2** console to provide both SYS-LINK V2 input and output. The console may be used as either a 'slave' or a 'master'. For information on fitting the option refer to document AP5737.



Linking consoles

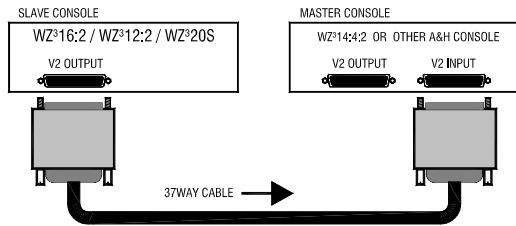

Plug the 'slave' console SYS-LINK V2 output into the 'master' console SYS-LINK V2 input. Make sure the connectors are fully plugged in and their securing screws tightened.

If one console has more than one SYS-LINK connector, plug into the socket marked 'A'.

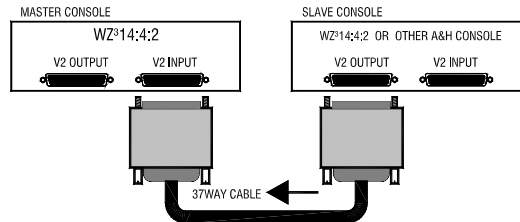
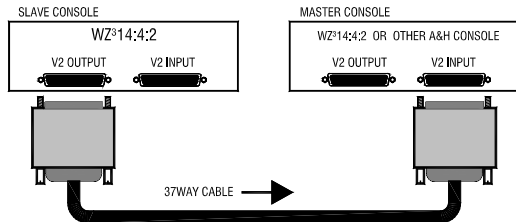

SYS-LINK V2 to V2 connection

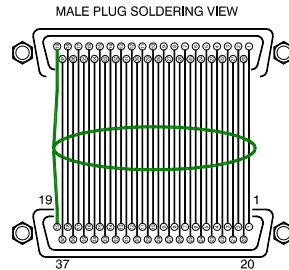
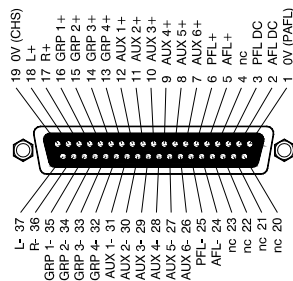

37way male to male D-type cable wired one to one. 36-core shielded cable with screen soldered to pin 19.

Recommended cable length 2.9 metres, maximum length less than 5 metres.

SYS-LINK V2 to V1 connection

37way male to 25way male D-type cable wired as shown below. Minimum 18-core shielded cable with screen soldered to chassis at both ends. Maximum cable length 2.9 metres.

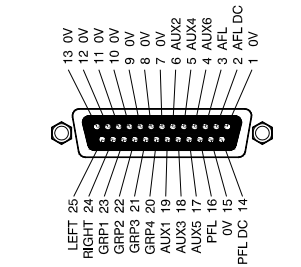

A suitable cable is available from Allen & Heath – part number **AH6552**

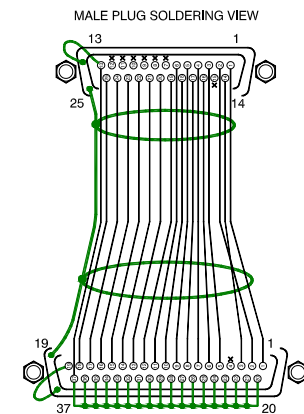

25way	37way	25way	37way	
Pin 1	>	Pin 18	>	10
Pin 2	>	Pin 19	>	12
Pin 3	>	Pin 20	>	13
Pin 4	>	Pin 21	>	14
Pin 5	>	Pin 22	>	15
Pin 6	>	Pin 23	>	16
Pin 14	>	Pin 24	>	17
Pin 16	>	Pin 25	>	18
Pin 17	>			

Pin 13 > 20 to 37 (linked 0V) (pin 13 also connected to 25way chassis)

37way Pin 19 = chassis

25way Pins 7 to 12, 15 not connected

37way Pin 4 not connected

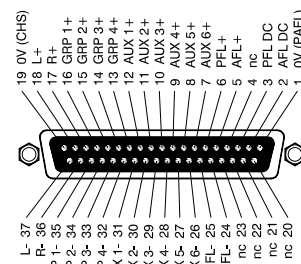

(Pin allocations shown are for 'A' connectors – adapter cable is also suitable for 'B' connectors)

Custom applications

To connect other audio equipment using the SYS-LINK connectors always ensure unused audio inputs are linked to 0V ground at the input connector. This is to prevent interference pickup on unterminated high impedance inputs. Do not link unused outputs to ground. Connect line level signals of -2dBu. Use balanced connections where possible. For unbalanced signals link signal '-' to 0V. To activate PFL/AFL link PFL DC to 0V through a 15k ohm resistor (37 way Pins 3 to 1).

If you require further information or advice please contact Allen & Heath technical support.