

User Guide



Introduction

Welcome to the Allen & Heath **PL-7** LCD display panel. This is part of the **PL-Series** of daisy chainable wall plates and remote controllers available for the **iDR-4** and **iDR-8** audio mix processor systems. Adding these devices greatly extends the capability of the system. The **PL-7** features a 2 x 16 character LCD able to display important system information and pre-programmed user text at locations remote from the **iDR** main unit. The display is backlit to ensure it can be easily read in all lighting conditions. Each line may be separately configured by the installer using the **iDR** System Manager software to display:

- Day and time
- iDR unit name
- Current patch name
- User defined text up to 16 characters per line

The **PL-7** module has an attractively styled face plate with fixing holes for wall cavity or custom furniture mounting, and rubber feet for free standing operation. It connects to the **iDR** PL-Anet serial port using CAT5 cable which can be conveniently routed around the installation to provide for a network of different types of **PL** remote controllers. Two underside RJ45 sockets connect the input and pass PL-Anet on to the next **PL** device. A terminator plug is provided to be plugged in if the **PL-7** is the last unit in the chain.

An optional face plate with pre-punched cutout is separately available if you wish to mount a wall plate controller assembly such as the **PL-3** or **PL-4** within the **PL-7** module itself. This provides remote controls such as switches, rotary encoder, LED displays and infra-red detector in addition to the LCD display. The fitted **PL** module is connected to the PL-Anet network within the **PL-7**. For information on the full range of **PL** products available visit our web site <http://www.allen-heath.com>.

The **PL-7** can also be ordered with the **PL-4** controller already fitted.

Applications

A few examples are shown in the diagram here. By itself the **PL-7** provides a convenient display of system information at any point within an installation. With another **PL** device such as the **PL-4** fitted internally it adds remote control and additional LED display within a single compact module. Together with one or more similarly styled **PL-6** fader or **PL-10** rotary encoder modules it provides additional control and/or information display to create an easy to use remote mix station. This is ideally suited to installations such as multi-function venues and houses of worship where a variety of regular events may be controlled by non-skilled operators at different locations.

Planning the system

An installation may comprise several different combinations of **PL** devices, for example room wall plates for volume control and source select, fader controllers and one or more **PL-7** modules. The maximum number of **PL** devices that can be connected depends on their type and the distances involved. You can connect up to 8x **PL-7** units in a system, but fewer if long distances or additional **PL** types are involved. Long distances up to 300m (1000'), and star point connection are possible if the optional **PL-9** PL-Anet hub is used. It is important that you check the possibilities first by referring to the **PL** Combinations Calculator spreadsheet available from the Allen & Heath web site.

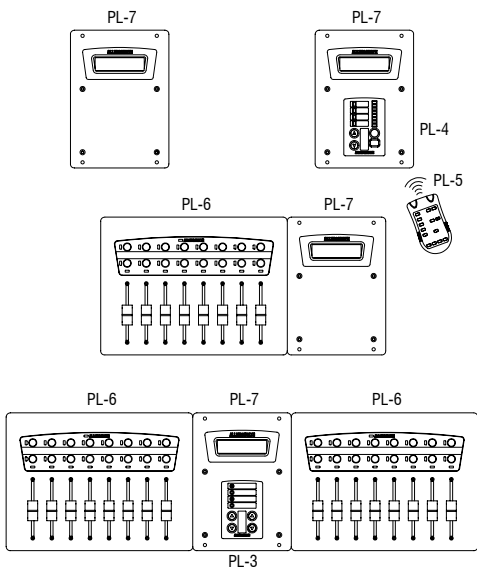

This product complies with the European Electromagnetic Compatibility directives 89/336/EEC & 92/31/EEC.

NOTE: Any changes or modifications to the equipment not approved by Allen & Heath could void the compliance of the equipment. Whilst we believe the information in this guide to be reliable we do not assume responsibility for inaccuracies. We also reserve the right to make changes in the interest of further product development.

Copyright© 2008 Allen & Heath Ltd. All rights reserved.

IMPORTANT :



Observe the local installation standards which may apply regarding the grade of cable and installation methods. Test for correct wiring and installation before switching the equipment on. Do not install the equipment where it is subject to moisture, heat or excessive movement.



Connect this equipment to the Allen & Heath PL-Anet port only. Connect only PL equipment to PL-Anet.

Installing the PL-7 Cutting template details are shown here for mounting the **PL-7** into a wall or furniture. Secure the unit in place using 4x fixing screws up to 3.5mm diameter. The chassis and plate are grounded through the PL-Anet cable shield. Check your installation requirements to see if any additional safety grounding is needed.

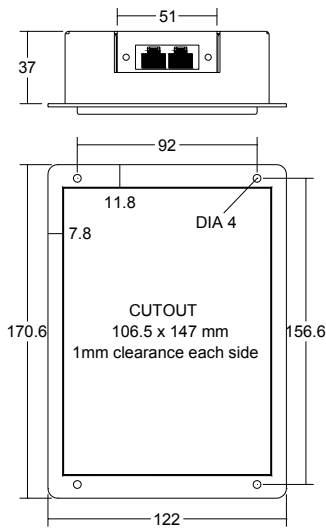

Fitting an internal PL device A single wall plate sized module such as the **PL-3** or **PL-4** may be fitted into the **PL-7**. This adds switch and infra-red control to the **PL-7**.

A kit of parts including replacement front panel and internal cables is available from Allen & Heath, part number **003-862**. Refer to Fitting Instructions sheet **AP7311** that comes with the kit or can be downloaded from our web site. Note that the internal SW1 and SW2 switches should be set as shown below.

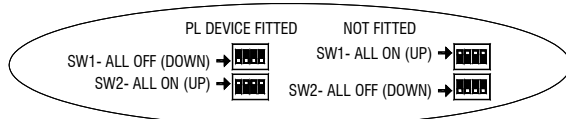
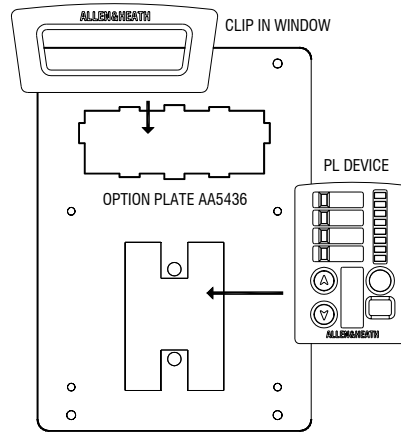

Connecting to PL-Anet PL-Anet is the proprietary Allen & Heath system for daisy chaining **PL** remote controllers. It is an RS485 serial connection that uses CAT5 STP cable to communicate between devices over long distances. The connection includes +20V DC to power the connected devices. Use flame retardant CAT5 STP (shielded twisted pair) RJ45 cables. The **iDR-8** main unit port is shown here.

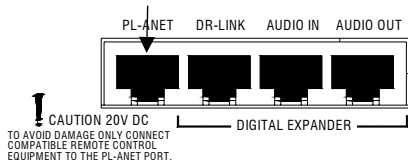

The **PL-7** has underside RJ45 ports for connecting to PL-Anet. These are recessed so that the cables can be hidden from view. The IN port connects to the previous unit in the chain. The OUT port connects to the next unit, or end of chain termination. As with any RS485 system, the last **PL** device needs to have a terminating resistor fitted to its output port. The **PL-7** is shipped with an RJ45 terminator plug with this resistor built in. If the **PL-7** is the only unit or last unit connected make sure the terminator is plugged into its output port.

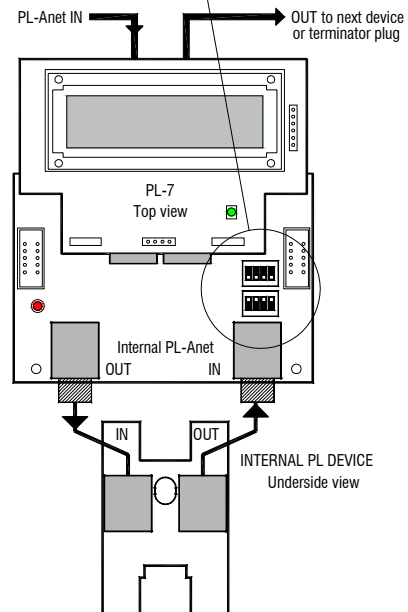
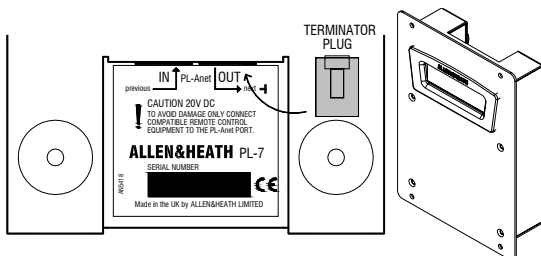

Using the PL-7 Ensure that the **iDR** PL-Anet port is enabled with its green 'active' LED lit. If not, use the **iDR** System Manager software Communications Option menu to enable the port. Plug in the PL-Anet cable. The screen should display icons on the toolbar for each PL device it recognises. If an internal **PL device** is fitted then it will be recognised in the chain before the **PL-7**. Check that the **PL-7** LCD lights up and displays text. The 2x16 character LCD display is configured using the **iDR** System Manager software. Refer to the Help file that comes with the software.

We hope you enjoy using the **PL-7**.

Testing the wiring Before powering up the system make sure all the wiring is inspected and continuity tested. This is important as wiring errors may result in damage to the equipment.

If further assistance is required please visit our web site www.allen-heath.com or contact Allen & Heath technical support in your territory.